

# Dell PowerEdge T630 Owner's Manual

Regulatory Model: E25S Series  
Regulatory Type: E25S001



# Notes, Cautions, and Warnings

 **NOTE:** A NOTE indicates important information that helps you make better use of your computer.

 **CAUTION:** A CAUTION indicates either potential damage to hardware or loss of data and tells you how to avoid the problem.

 **WARNING:** A WARNING indicates a potential for property damage, personal injury, or death.

**Copyright © 2014 Dell Inc. All rights reserved.** This product is protected by U.S. and international copyright and intellectual property laws. Dell™ and the Dell logo are trademarks of Dell Inc. in the United States and/or other jurisdictions. All other marks and names mentioned herein may be trademarks of their respective companies.

2014 - 06

Rev. A00

# Contents

<b>1 About your system.....</b>	<b>9</b>
Supported configurations.....	9
Front-panel features and indicators.....	10
LCD panel features.....	13
Home screen.....	14
Setup menu.....	14
View menu.....	15
Hard-drive indicator codes.....	16
Back-panel features and indicators.....	17
NIC indicator codes.....	19
Power indicator codes.....	19
Documentation matrix.....	22
Quick Resource Locator .....	23
<b>2 Performing initial system configuration .....</b>	<b>24</b>
Setting up your system.....	24
Methods of setting up and configuring the iDRAC IP address .....	24
Information about logging in to iDRAC.....	25
Methods of installing the operating system.....	25
Remote management .....	25
Downloading and installing drivers and firmware.....	25
<b>3 Pre-operating system management applications.....</b>	<b>27</b>
Navigation keys.....	27
About System Setup.....	28
Enabling Console Redirection.....	28
Entering System Setup.....	28
System Setup Main Menu.....	28
System BIOS screen details.....	28
System Information screen details.....	29
Memory Settings screen details.....	30
Processor Settings screen details.....	31
SATA Settings screen details.....	33
Boot Settings screen details.....	35
Network Settings screen details.....	36
Integrated Devices screen details.....	36
Serial Communication screen details.....	38
System Profile Settings screen details.....	38

System Security settings screen details.....	40
Miscellaneous Settings screen details.....	42
About Boot Manager.....	43
Entering Boot Manager .....	43
Boot Manager main menu.....	43
Changing the boot order.....	43
Choosing the system boot mode.....	44
Assigning a system and setup password.....	44
Deleting or changing an existing system password.....	45

## **4 Installing and removing system components.....46**

Safety instructions.....	46
Before working inside your system.....	46
After working inside your system.....	46
Recommended tools.....	47
Front bezel (optional).....	47
Installing the front bezel.....	47
Removing the front bezel.....	48
System feet.....	48
Removing the system feet.....	48
Installing the system feet.....	49
Caster wheels (optional)—tower mode.....	50
Installing caster wheels.....	50
Removing caster wheels.....	51
Removing the system cover.....	52
Installing the system cover.....	52
Inside the system.....	53
Cooling shroud.....	54
Removing the cooling shroud.....	55
Installing the cooling shroud.....	56
Cooling fans.....	56
Removing a cooling fan.....	56
Installing a cooling fan.....	57
Cooling-fan assembly (optional).....	58
Removing the cooling-fan assembly (optional).....	58
Installing the cooling-fan assembly (optional).....	59
System memory.....	59
General memory module installation guidelines.....	61
Mode-specific guidelines.....	61
Sample memory configurations.....	62
Removing memory modules.....	65
Installing memory modules.....	66



Flex bays.....	68
Removing a flex bay.....	68
Installing a flex bay.....	69
Hard drives.....	70
Removing a hot-swap hard drive.....	70
Installing a hot-swap hard drive.....	71
Removing a 2.5 inch hard-drive blank.....	72
Installing a 2.5 inch hard-drive blank.....	72
Removing a 3.5 inch hard-drive blank.....	73
Installing a 3.5 inch hard-drive blank.....	74
Installing a 2.5 inch hard drive into a 3.5 inch hard-drive adapter.....	74
Removing a 2.5 inch hard drive from a 3.5 inch hard-drive adapter.....	75
Installing a hard-drive adapter into a hard-drive carrier.....	75
Removing a hard-drive adapter from a hard-drive carrier.....	76
Removing a hard drive from a hard-drive carrier.....	76
Installing a hard drive into a hard-drive carrier.....	77
Optical drives and tape drives.....	77
Removing the optical drive or tape drive.....	78
Installing the optical drive or tape drive.....	81
Removing the slim optical drive blank.....	81
Installing the slim optical drive blank.....	82
Internal USB memory key (optional).....	82
Replacing the internal USB key.....	83
Expansion card holder.....	84
Removing the expansion card holder.....	84
Installing the expansion card holder.....	84
Expansion cards.....	85
Expansion card installation guidelines.....	85
Removing an expansion card.....	86
Installing an expansion card.....	87
GPU card holder (optional).....	88
Removing the GPU card holder.....	88
Installing the GPU card holder.....	89
GPU cards (optional).....	90
GPU card installation guidelines.....	90
Removing a GPU card.....	90
Installing a GPU card.....	92
Internal dual SD module.....	92
Removing the internal dual SD module .....	92
Installing the internal dual SD module .....	94
Internal SD card.....	94
Removing an internal SD card.....	94

Installing an internal SD card.....	95
Processors.....	95
Removing a processor.....	95
Installing a processor.....	99
Power supplies.....	101
Hot Spare feature.....	102
Removing an AC power supply unit.....	102
Installing an AC power supply unit.....	103
Wiring instructions for a DC power supply unit.....	104
Removing a DC power supply unit.....	106
Installing a DC power supply unit.....	107
Removing the power supply unit blank.....	108
Installing the power supply unit blank.....	109
System battery.....	109
Replacing the system battery.....	109
Hard-drive backplane.....	110
Removing the hard-drive backplane.....	111
Installing the hard-drive backplane.....	129
SD vFlash media card.....	129
Replacing an SD vFlash media card.....	129
Control panel assembly.....	130
Removing the control panel assembly.....	130
Installing the control panel assembly.....	132
System board.....	133
Removing the system board.....	133
Installing the system board.....	134
Trusted Platform Module.....	136
Installing the Trusted Platform Module .....	136
Re-enabling the TPM for BitLocker users.....	137
Re-enabling the TPM for TXT users.....	137
Power interposer board and power distribution board.....	138
Removing the power interposer board.....	138
Removing the power distribution board.....	139
Installing the power distribution board.....	140
Installing the power interposer board.....	141
System top cover.....	141
Removing the system top cover.....	141
Installing the system top cover.....	142

## **5 Converting the system from tower mode to rack mode..... 144**

Safety instructions.....	144
Preparing a system for conversion from tower mode to rack mode .....	144

<b>6 Troubleshooting your system.....</b>	<b>148</b>
Safety first—for you and your system.....	148
Troubleshooting system startup failure.....	148
Troubleshooting external connections.....	148
Troubleshooting the video subsystem.....	148
Troubleshooting a USB device.....	148
Troubleshooting iDRAC Direct (USB XML configuration).....	149
Troubleshooting iDRAC Direct (laptop connection).....	150
Troubleshooting a serial I/O device.....	150
Troubleshooting a NIC.....	150
Troubleshooting a wet system.....	151
Troubleshooting a damaged system.....	152
Troubleshooting the system battery.....	152
Troubleshooting power supply units.....	153
Power source problems.....	153
Power supply unit problems.....	153
Troubleshooting cooling problems.....	154
Troubleshooting cooling fans.....	154
Troubleshooting system memory.....	155
Troubleshooting an internal USB key.....	156
Troubleshooting an SD card.....	156
Troubleshooting an optical drive.....	157
Troubleshooting a tape backup unit.....	157
Troubleshooting a hard drive.....	158
Troubleshooting a storage controller.....	159
Troubleshooting expansion cards.....	159
Troubleshooting processors.....	160
System messages.....	161
Warning messages.....	161
Diagnostic messages.....	161
Alert messages.....	161
<b>7 Using system diagnostics.....</b>	<b>162</b>
Dell Embedded System Diagnostics.....	162
When to use the Embedded System Diagnostics.....	162
Running the Embedded System Diagnostics from Boot Manager.....	162
Running the Embedded System Diagnostics from the Dell Lifecycle Controller.....	162
System diagnostic controls.....	163
<b>8 Jumpers and connectors.....</b>	<b>164</b>
System board connectors.....	164

System board jumper settings.....	166
Disabling a forgotten password.....	166

**9 Technical specifications.....168**

**10 Getting help.....175**

Contacting Dell.....	175
Locating your system service tag.....	175
Quick Resource Locator (QRL).....	175

## About your system

The Dell PowerEdge T630 is a rackable tower server that support up to two processors based on the Intel Xeon E5-2600 v3 processor family, up to 24 DIMMs, and storage capacity of up to 32 hard drives/SSDs.

 **NOTE:** The T630 systems support only internal, hot-swappable hard drives.

## Supported configurations

System	Configurations
3.5 inch hard-drive system	Up to eight 3.5 inch hard drives
	Up to eighteen 3.5 inch hard drives
	Up to eight 3.5 inch hard drives plus four Dell PowerEdge Express Flash devices (PCIe SSDs) in a flex bay
2.5 inch hard-drive system	Up to sixteen 2.5 inch hard drives
	Up to sixteen 2.5 inch hard drives plus four Dell PowerEdge Express Flash devices (PCIe SSDs) in a flex bay
	Up to sixteen 2.5 inch hard drives in the hard-drive bay plus up to sixteen 2.5 inch hard drives in the flex bay
	Up to thirty-two 2.5 inch hard drives

# Front-panel features and indicators

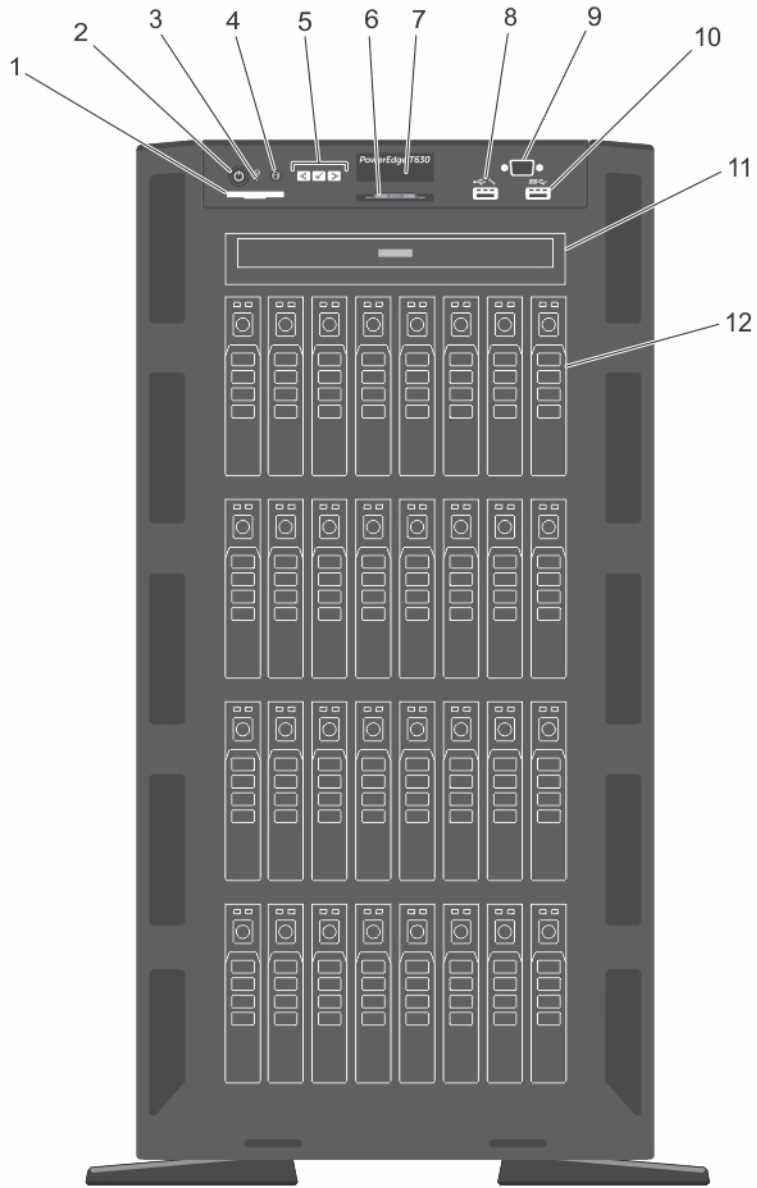

Figure 1. Front-panel features and indicators— 2.5 inch hard-drive chassis

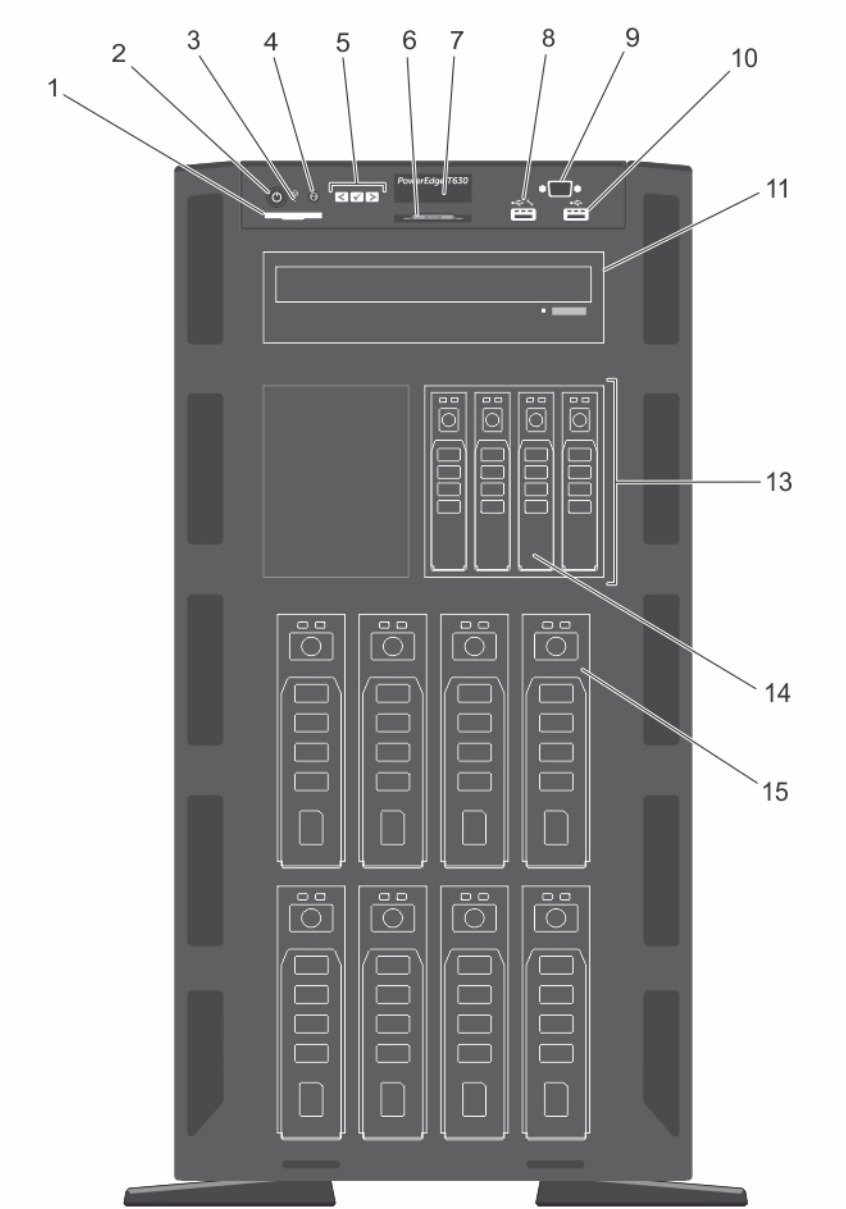











Figure 2. Front-panel features and indicators— 3.5 inch hard-drive plus four PCIe SSD chassis

Item	Indicator, button, or connector	Icon	Description
1	SD vFlash card slot		Allows you to insert a vFlash media card. The vFlash media card is an SD card that extends the functionalities of the iDRAC enterprise card.
2	Power-on indicator, power button		<p>The power-on indicator lights when the system power is on. The power button controls the power supply output to the system.</p> <p> <b>NOTE:</b> On ACPI-compliant operating systems, turning off the system using the power button causes the system to perform a graceful shutdown before power to the system is turned off.</p>
3	NMI button		<p>Use this button to troubleshoot software and device driver errors when running certain operating systems. This button can be pressed using the end of a paper clip.</p> <p>Use this button only if directed to do so by qualified support personnel or by the operating system documentation.</p>
4	System identification button		<p>The identification buttons on the front and back panels can be used to locate a particular system within a rack. When one of these buttons is pressed, the LCD panel on the front and the system status indicator on the back flash until one of the buttons is pressed again.</p> <p>Press to toggle the system ID ON and OFF.</p> <p>If the system stops responding during POST, press and hold the system ID button for more than five seconds to enter BIOS progress mode.</p> <p>To reset iDRAC (if not disabled in &lt;F2&gt; iDRAC setup) press and hold for more than 15 seconds.</p>
5	LCD menu buttons		Allows you to navigate the control panel LCD menu.
6	Information tag		A slide-out label panel, which allows you to record system information such as Service Tag, NIC, MAC address, and so on as per your need.
7	LCD panel		Displays system ID, status information, and system error messages. The LCD lights blue during normal system operation. When the system needs attention, the LCD lights amber, and displays an error code followed by descriptive text.



Item	Indicator, button, or connector	Icon	Description
			 <b>NOTE:</b> If the system is connected to a power source and an error is detected, the LCD lights amber regardless of whether the system is turned on or off.
8	USB management port/ iDRAC Direct port		The USB management port can function as a regular USB port or provide access to the iDRAC Direct features. For more information, see the Integrated Dell Remote Access Controller User's Guide at <a href="http://dell.com/esmmanuals">dell.com/esmmanuals</a> . This port is USB 2.0-compliant
9	VGA connector		Allows you to connect a VGA display to the system.   <b>NOTE:</b> The VGA connector is available only in the rack-mode configuration of your system. For information on converting your system from tower to the rack mode, see <a href="#">Preparing a system for conversion from tower mode to rack mode</a> .
10	USB connector		Allows you to connect USB devices to the system. This port is USB 3.0-compliant.
11	Optical drive or tape-drive bay		Allows you to install optical drives or tape drives. For more information on supported optical drives and tape drives, see <a href="#">Optical drives and tape drives</a> .
12, 14, 15	Physical drives		3.5 inch hard drives, 2.5 inch hard drives, and PCIe SSDs
13	Flex Bay		Supports up to four PCIe SSDs or up to sixteen 2.5 inch hard drives depending on the system configuration.

## LCD panel features

The LCD panel of your system provides system information and status and error messages to indicate if the system is operating correctly or if the system needs attention. For more information on error messages, see the Dell Event and Error Messages Reference Guide at [dell.com/esmmanuals](http://dell.com/esmmanuals).

- The LCD backlight lights blue during normal operating conditions and lights amber to indicate an error condition.
- The LCD backlight is off when the system is in standby mode and can be turned on by pressing either the Select, Left, or Right button on the LCD panel.
- The LCD backlight remains off if LCD messaging is turned off through the iDRAC utility, the LCD panel, or other tools.

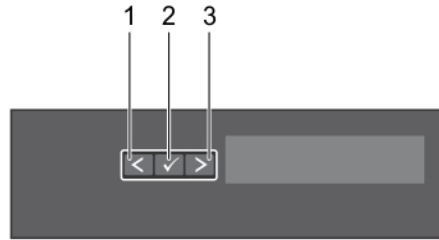





Figure 3. LCD panel features

Item	Button	Description
1	Left	Moves the cursor back in one-step increments.
2	Select	Selects the menu item highlighted by the cursor.
3	Right	Moves the cursor forward in one-step increments. During message scrolling: <ul style="list-style-type: none"> <li>• Press and hold the button to increase scrolling speed.</li> <li>• Release the button to stop.</li> </ul>

 **NOTE:** The display will stop scrolling when the button is released. After 45 seconds of inactivity the display will start scrolling.

## Home screen

The Home screen displays user-configurable information about the system. This screen is displayed during normal system operation when there are no status messages or errors. When the system is in standby mode, the LCD backlight turns off after five minutes of inactivity if there are no error messages. Press one of the three navigation buttons (Select, Left, or Right) to view the Home screen.

To navigate to the Home screen from another menu, continue to select the up arrow  until the Home icon  is displayed, and then select the Home icon.

From the Home screen, press the Select button to enter the main menu.

## Setup menu

 **NOTE:** When you select an option in the Setup menu, you must confirm the option before proceeding to the next action.

Option	Description
iDRAC	Select <b>DHCP</b> or <b>Static IP</b> to configure the network mode. If <b>Static IP</b> is selected, the available fields are <b>IP</b> , <b>Subnet (Sub)</b> , and <b>Gateway (Gtw)</b> . Select <b>Setup DNS</b> to enable DNS and to view domain addresses. Two separate DNS entries are available.
Set error	Select <b>SEL</b> to display LCD error messages in a format that matches the IPMI description in the SEL. This is useful when trying to match an LCD message with an SEL entry.

Option	Description
	Select <b>Simple</b> to display LCD error messages in a simplified user-friendly description. See System Error Messages for a list of messages in this format.
<b>Set home</b>	Select the default information to be displayed on the LCD Home screen. See <b>View Menu</b> to see the options and option items that can be set as the default on the Home screen.

## View menu

 **NOTE:** When you select an option in the View menu, you must confirm the option before proceeding to the next action.

Option	Description
iDRAC IP	Displays the <b>IPv4</b> or <b>IPv6</b> addresses for iDRAC8. Addresses include <b>DNS (Primary and Secondary)</b> , <b>Gateway</b> , <b>IP</b> , and <b>Subnet</b> (IPv6 does not have Subnet).
MAC	Displays the MAC addresses for <b>iDRAC</b> , <b>iSCSI</b> , or <b>Network</b> devices.
Name	Displays the name of the <b>Host</b> , <b>Model</b> , or <b>User String</b> for the system.
Number	Displays the <b>Asset tag</b> or the <b>Service tag</b> for the system.
Power	Displays the power output of the system in BTU/hr or Watts. The display format can be configured in the <b>Set home</b> submenu of the <b>Setup</b> menu.
Temperature	Displays the temperature of the system in Celsius or Fahrenheit. The display format can be configured in the <b>Set home</b> submenu of the <b>Setup</b> menu.

## Hard-drive indicator codes

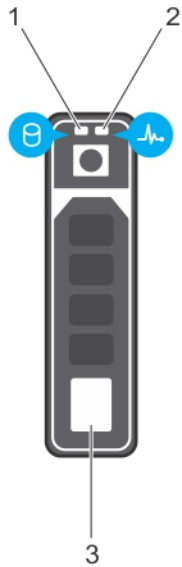

**Figure 4. Hard-drive indicators**



1. hard-drive activity indicator
2. hard-drive status indicator
3. hard drive



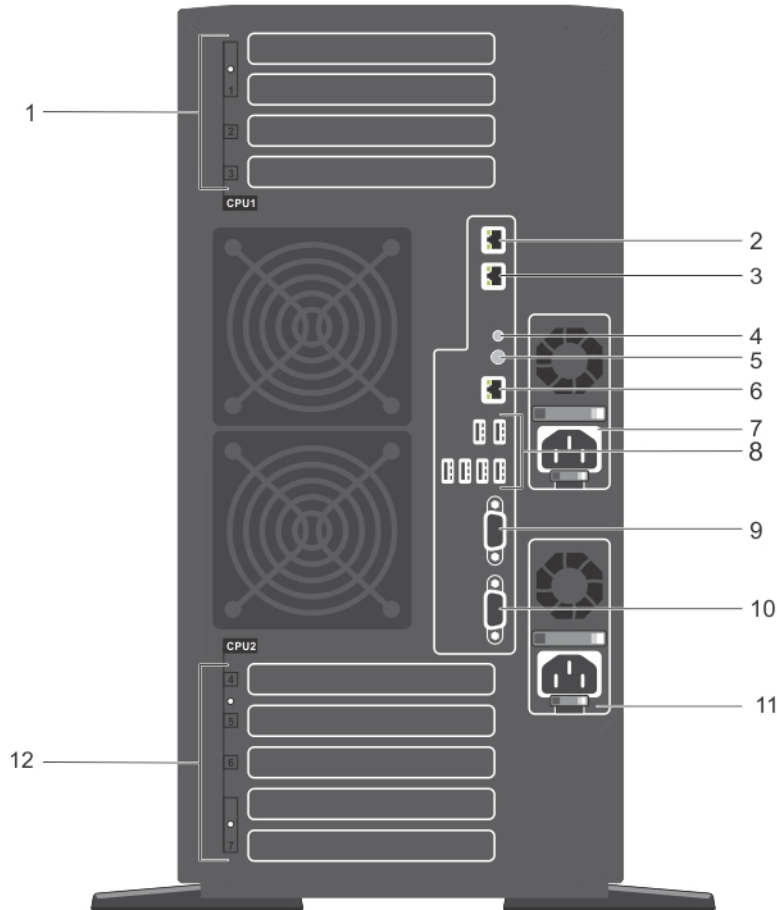

**NOTE:** If the hard drive is in Advanced Host Controller Interface (AHCI) mode, the status indicator (on the right side) does not function and remains off.

Drive-status indicator pattern (RAID only)	Condition
Blinks green two times per second	Identifying drive or preparing for removal.
Off	Drive ready for insertion or removal.
	<b>NOTE:</b> The drive status indicator remains off until all hard drives are initialized after the system is turned on. Drives are not ready for insertion or removal during this time.
Blinks green, amber, and turns off	Predicted drive failure
Blinks amber four times per second	Drive failed
Blinks green slowly	Drive rebuilding
Steady green	Drive online
Blinks green three seconds, amber three seconds, and turns off six seconds	Rebuild aborted

## Back-panel features and indicators



Item	Indicator, Button, or Connector	Icon	Description
1	PCIe expansion card slots (3) (processor 1)		Allows you to connect up to two PCI Express expansion cards and one PERC card.
2, 3	Ethernet connectors		Two integrated 10/100/1000 Mbps NIC connectors.
4	System identification connector		Allows you to connect the optional system status indicator assembly through the optional cable management arm.
5	System identification button		The identification buttons on the front and back panels can be used to locate a particular system

Item	Indicator, Button, or Connector	Icon	Description
			<p>within a rack. When one of these buttons is pressed, the LCD panel on the front and the system status indicator on the back flash until one of the buttons is pressed again.</p> <p>Press to toggle the system ID on and off.</p> <p>If the system stops responding during POST, press and hold the system ID button for more than five seconds to enter the BIOS progress mode.</p> <p>To reset iDRAC (if not disabled in F2 iDRAC setup), press and hold for more than 15 seconds.</p>
6	iDRAC Enterprise port		<p>Dedicated management port.</p> <p> <b>NOTE:</b> The port is available for use only if the iDRAC Enterprise license is installed on your system.</p>
7	Power supply (PSU1)		<p><b>AC</b>                    495 W, 750 W, 1100 W, or 1600 W</p> <p><b>or</b></p> <p><b>DC</b>                     1100 W</p>
8	USB connectors (6)		Allows you to connect USB devices to the system. Four ports are USB 2.0-compliant and two ports are USB 3.0-compliant.
9	Video connector		Allows you to connect a VGA display to the system.
10	Serial connector		Allows you to connect a serial device to the system.
11	Power supply (PSU2)		<p><b>AC</b>                    495 W, 750 W, 1100 W, or 1600 W</p> <p><b>or</b></p> <p><b>DC</b>                     1100 W</p>
12	PCIe expansion card slots full height (4) (processor 2)		Connects up to four full-height PCI Express expansion cards.

## NIC indicator codes

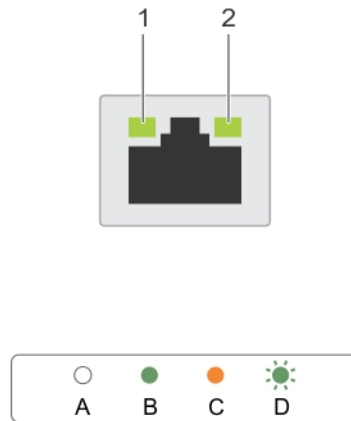

**Figure 5. NIC indicators**

1. link indicator

2. activity indicator

Indicator	Indicator code
Link and activity indicators are off	The NIC is not connected to the network.
Link indicator is green	The NIC is connected to a valid network at its maximum port speed (1 Gbps or 10 Gbps).
Link indicator is amber	The NIC is connected to a valid network at less than its maximum port speed.
Activity indicator is blinking green	Network data is being sent or received.

## Power indicator codes

Each AC power supply unit (PSU) has an illuminated translucent handle and each DC power supply unit (when available) has an LED that serves as an indicator to show whether power is present or a power fault has occurred.



**Figure 6. AC power supply unit status indicator**

1. AC power supply unit status indicator/handle

Convention	Power indicator pattern	Condition
A	Green	The handle indicator lights green indicating that a valid power source is connected to the power supply unit and that the power supply unit is operational.
B	Flashing green	When updating the firmware of the power supply unit, the power supply unit handle flashes green.
C	Flashing green and turns off	When hot-adding a power supply unit (PSU), the power supply unit handle flashes green five times at 4 Hz rate and turns off. This indicates that the power supply unit is mismatched with the other power supply unit (in terms of efficiency, feature set, health status, and supported voltage). Replace the power supply unit that has the flashing indicator with a power supply unit that matches the capacity of the other installed power supply unit.
		 <b>NOTE:</b> For AC power supplies, use only PSUs with the Extended Power Performance (EPP) label on the back. Mixing PSUs from previous generations of servers can result in a PSU mismatch condition or failure to power on.
D	Flashing amber	Indicates a problem with the power supply unit.



Convention	Power indicator pattern	Condition
		<p>△ CAUTION: When correcting a power supply unit mismatch, replace only the power supply unit with the flashing indicator. Swapping the opposite power supply unit to make a matched pair can result in an error condition and unexpected system shutdown. To change from a High Output configuration to a Low Output configuration or vice versa, you must power down the system.</p> <p>△ CAUTION: AC power supplies support both 220 V and 110 V input voltages with the exception of Titanium power supplies, which support only 220 V. When two identical power supplies receive different input voltages, they can output different wattages, and trigger a mismatch.</p> <p>△ CAUTION: If two power supplies are used, they must be of the same type and have the same maximum output power.</p> <p>△ CAUTION: Combining AC and DC power supplies is not supported and triggers a mismatch.</p>
E	Not lit	Power is not connected.

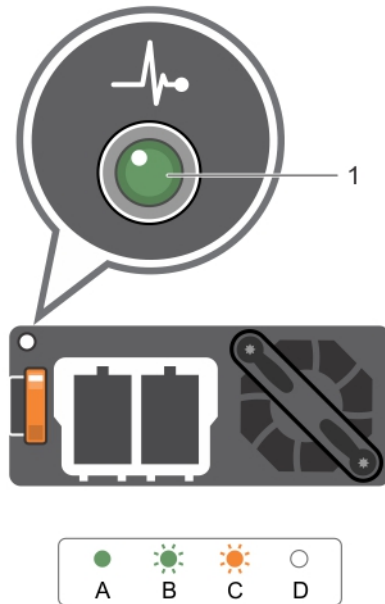





Figure 7. DC power supply unit status indicator

1. DC power supply unit status indicator

Convention	Power indicator pattern	Condition
A	Green	The handle/LED indicator lights green indicating that a valid power source is connected to the power supply unit and that the power supply unit is operational.
B	Flashing green	When hot-adding a power supply unit, power supply unit LED flashes green. This indicates that the power supply unit is mismatched with the other power supply unit (in terms of efficiency, feature set, health status, and supported voltage). Replace the power supply unit that has the flashing indicator with a power supply unit that matches the capacity of the other installed power supply unit.
C	Flashing amber	<p>Indicates a problem with the power supply unit.</p> <p> <b>CAUTION: When correcting a power supply unit mismatch, replace only the power supply unit with the flashing indicator. Swapping the opposite power supply unit to make a matched pair can result in an error condition and unexpected system shutdown. To change from a High Output configuration to a Low Output configuration or vice versa, you must power down the system.</b></p> <p> <b>CAUTION: AC power supplies support both 220 V and 110 V input voltages with the exception of Titanium power supplies, which support only 220 V. When two identical power supplies receive different input voltages, they can output different wattages, and trigger a mismatch.</b></p> <p> <b>CAUTION: If two power supplies are used, they must be of the same type and have the same maximum output power.</b></p> <p> <b>CAUTION: Combining AC and DC power supplies is not supported and triggers a mismatch.</b></p>
D	Not lit	Power is not connected.

## Documentation matrix

The documentation matrix provides information on documents that you can refer to for setting up and managing your system.

To...	Refer to...
Install your system into a rack	Rack documentation included with your rack solution
Set up your system and know the system technical specifications	<i>Getting Started With Your System</i> that shipped with your system or see <a href="https://dell.com/poweredge/manuals">dell.com/poweredge/manuals</a>
Install the operating system	Operating system documentation at <a href="https://dell.com/operatingsystemmanuals">dell.com/operatingsystemmanuals</a>

To...	Refer to...
Get an overview of the Dell Systems Management offerings	Dell OpenManage Systems Management Overview Guide at <a href="http://dell.com/openmanagemanuals">dell.com/openmanagemanuals</a>
Configure and log in to iDRAC, set up managed and management system, know the iDRAC features and troubleshoot using iDRAC	Integrated Dell Remote Access Controller User's Guide at <a href="http://dell.com/esmmanuals">dell.com/esmmanuals</a>
Know about the RACADM subcommands and supported RACADM interfaces	RACADM Command Line Reference Guide for iDRAC and CMC at <a href="http://dell.com/esmmanuals">dell.com/esmmanuals</a>
Launch, enable and disable Lifecycle Controller, know the features, use and troubleshoot Lifecycle Controller	Dell Lifecycle Controller User's Guide at <a href="http://dell.com/esmmanuals">dell.com/esmmanuals</a>
Use Lifecycle Controller Remote Services	Dell Lifecycle Controller Remote Services Quick Start Guide at <a href="http://dell.com/esmmanuals">dell.com/esmmanuals</a>
Set up, use, and troubleshoot OpenManage Server Administrator	Dell OpenManage Server Administrator User's Guide at <a href="http://dell.com/openmanagemanuals">dell.com/openmanagemanuals</a>
Install, use and troubleshoot OpenManage Essentials	Dell OpenManage Essentials User's Guide at <a href="http://dell.com/openmanagemanuals">dell.com/openmanagemanuals</a>
Know the features of the storage controller cards, deploy the cards, and manage the storage subsystem	Storage controller documentation at <a href="http://dell.com/storagecontrollermanuals">dell.com/storagecontrollermanuals</a>
Check the event and error messages generated by the system firmware and agents that monitor system components	Dell Event and Error Messages Reference Guide at <a href="http://dell.com/esmmanuals">dell.com/esmmanuals</a>

## Quick Resource Locator

Use the Quick Resource Locator (QRL) to get immediate access to system information and how-to videos. This can be done by visiting [dell.com/QRL](http://dell.com/QRL) or by using your smartphone or tablet and a model specific Quick Resource (QR) code located on your Dell PowerEdge system. To try out the QR code, scan the following image.



# Performing initial system configuration

After you receive your PowerEdge system, you must set up your system, install the operating system, and set up and configure the system iDRAC IP address for system management.

## Setting up your system

1. Unpack the server.
2. Install the server into the rack. For more information on installing the server into the rack, see your system's *Rack Installation Placemat* at [dell.com/poweredgemanuals](http://dell.com/poweredgemanuals). For tower systems that can be converted to the rack mode, see [Preparing a system for conversion from tower mode to rack mode](#) to know how to convert the tower system to the rack mode configuration.
3. Connect any peripherals to the system.
4. Connect the system to its electrical outlet.
5. Turn the system on by pressing the power button or using iDRAC.
6. Turn on the attached peripherals.

## Methods of setting up and configuring the iDRAC IP address

You can set up the Integrated Dell Remote Access Controller (iDRAC) IP address by using one of the following interfaces:

1. iDRAC Settings utility.
2. Lifecycle Controller.
3. Dell Deployment Toolkit.
4. Server LCD panel.

You can configure iDRAC IP using:

1. iDRAC Web Interface.  
For more information, see the Integrated Dell Remote Access Controller User's Guide.
2. Remote Access Controller Admin (RACADM).  
For more information, see the RACADM Command Line Interface Reference Guide and the Integrated Dell Remote Access Controller User's Guide.
3. Remote Services that includes Web Services Management (WS-Man). For more information, see the Lifecycle Controller Remote Services Quick Start Guide.

For more information on setting up and configuring iDRAC, see the Integrated Dell Remote Access Controller User's Guide at [dell.com/esmmanuals](http://dell.com/esmmanuals).

## Information about logging in to iDRAC

You can log in to iDRAC as an iDRAC local user, as a Microsoft Active Directory user, or as a Lightweight Directory Access Protocol (LDAP) user. You can also log in using Single Sign-On or Smart Card. The default user name is **root** and password is **calvin**. For more information on logging in to iDRAC and iDRAC licenses, see the Integrated Dell Remote Access Controller User's Guide at [dell.com/esmmanuals](http://dell.com/esmmanuals).

You can also access the iDRAC using RACADM. For more information, see the RACADM Command Line Interface Reference Guide and the Integrated Dell Remote Access Controller User's Guide available at [dell.com/esmmanuals](http://dell.com/esmmanuals).

## Methods of installing the operating system

If the server is shipped without an operating system, install the supported operating system on the server using the following methods:

- Dell Systems Management Tools and Documentation media. See the operating system documentation at [dell.com/operatingsystemmanuals](http://dell.com/operatingsystemmanuals).
- Dell Lifecycle Controller. See the Lifecycle Controller documentation at [dell.com/esmmanuals](http://dell.com/esmmanuals).
- Dell OpenManage Deployment Toolkit. See the OpenManage documentation at [dell.com/openmanagemanuals](http://dell.com/openmanagemanuals).

For information on the list of operating systems supported on your system, see the operating systems support matrix at [dell.com/ossupport](http://dell.com/ossupport).

## Remote management

To perform out-of-band systems management using iDRAC, you must configure iDRAC for remote accessibility, set up the management station and managed system, and configure the supported Web browsers. For more information, see the Integrated Dell Remote Access Controller User's Guide at [dell.com/esmmanuals](http://dell.com/esmmanuals).

You can also remotely monitor and manage the server, using the Dell OpenManage Server Administrator (OMSA) software and OpenManage Essentials (OME) systems management console. For more information, see [dell.com/openmanagemanuals](http://dell.com/openmanagemanuals).

## Downloading and installing drivers and firmware

It is recommended that you download and install the latest BIOS, drivers, and systems management firmware on your system.

### Prerequisites

 **NOTE:** Ensure that you clear the web browser cache.

### Steps

1. Go to [dell.com/support/drivers](http://dell.com/support/drivers).
2. In the **Product Selection** section, enter the service tag of your system in the **Service Tag or Express Service Code** field.

 **NOTE:** If you do not have the service tag, select **Automatically detect my Service Tag for me** to allow the system to automatically detect your service tag, or select **Choose from a list of all Dell products** to select your product from the **Product Selection** page.

3. Click **Get drivers and downloads**.

The drivers that are applicable to your selection are displayed.

4. Download the drivers that you require to a diskette drive, USB drive, CD, or DVD.

# Pre-operating system management applications

The pre-operating system management applications for your PowerEdge system help you manage different settings and features of your system without booting to the operating system.

Your PowerEdge system has the following pre-operating system management applications:

- System Setup
- Boot Manager
- Dell Lifecycle Controller

Dell Lifecycle Controller allows you to perform useful tasks such as configuring BIOS and hardware settings, deploying operating system, updating drivers, changing RAID settings, and saving hardware profiles. For more information about Dell Lifecycle Controller, see the documentation at [dell.com/esmmanuals](http://dell.com/esmmanuals).

## Navigation keys

The navigation keys can help you access the pre-operating system management applications.

Key	Description
<PgUp>	Moves to the previous screen.
<PgDn>	Moves to the next screen.
Up arrow	Moves to the previous field.
Down arrow	Moves to the next field.
<Enter>	Enables you to type a value in the selected field (if applicable) or follow the link in the field.
Spacebar	Expands or collapses a drop-down list, if applicable.
<Tab>	Moves to the next focus area.
	 <b>NOTE:</b> This feature is applicable for the standard graphics browser only.
<Esc>	Moves to the previous page till you view the main screen. Pressing <Esc> in the main screen exits System BIOS/IDRAC Settings/Device Settings/Service Tag Settings and proceeds with system boot.
<F1>	Displays the System Setup help text.

## About System Setup

Using System Setup, you can configure the BIOS settings, iDRAC settings, and device settings of your system.

You can access System Setup in two ways:

- Standard Graphical Browser— This is enabled by default.
- Text Browser— This is enabled using Console Redirection.

 **NOTE:** By default, help text for the selected field is displayed in the graphical browser. To view the help text in the text browser, press <F1>.

## Enabling Console Redirection

To enable **Console Redirection**, in **System Setup**, select **System BIOS** → **Serial Communication** → **On with Console Redirection via COMx** (or **Auto** if a serial terminal is present).

## Entering System Setup

1. Turn on or restart your system.
2. Press <F2> immediately after you see the following message:  
<F2> = System Setup

If your operating system begins to load before you press <F2>, allow the system to finish booting, and then restart your system and try again.

## System Setup Main Menu

Option	Description
<b>System BIOS</b>	Enables you to configure BIOS settings.
<b>iDRAC Settings</b>	Enables you to configure iDRAC settings. The iDRAC Settings utility is an interface to set up and configure the iDRAC parameters using UEFI. You can enable or disable various iDRAC parameters by using the iDRAC Settings utility. For more information about this utility, see the Integrated Dell Remote Access Controller User's Guide at <a href="http://dell.com/esmanuals">dell.com/esmanuals</a> .
<b>Device Settings</b>	Enables you to configure device settings.

## System BIOS screen details

You can use the **System BIOS** screen to view BIOS settings as well as edit specific functions such as boot order, system password, setup password, setting RAID mode, and enabling or disabling USB ports.

To view the System BIOS screen, in the **System Setup Main Menu**, click **System BIOS**.

The **System BIOS** screen details are explained as follows:



Menu Item	Description
<b>System Information</b>	Displays information about the system such as the system model name, BIOS version, and Service Tag.
<b>Memory Settings</b>	Displays information and options related to installed memory.
<b>Processor Settings</b>	Displays information and options related to the processor such as speed, and cache size.
<b>SATA Settings</b>	Displays options to enable or disable the integrated SATA controller and ports.  <b>NOTE:</b> This setting is not available on PowerEdge T630.
<b>Boot Settings</b>	Displays options to specify the boot mode (BIOS or UEFI). Enables you to modify UEFI and BIOS boot settings.
<b>Integrated Devices</b>	Displays options to enable or disable integrated device controllers and ports, and to specify related features and options.
<b>Serial Communication</b>	Displays options to enable or disable the serial ports and specify related features and options.
<b>System Profile Settings</b>	Displays options to change the processor power management settings, and memory frequency.
<b>System Security</b>	Displays options to configure the system security settings such as system password, setup password, and TPM security. It also enables or disables the power and NMI buttons on the system.
<b>Miscellaneous Settings</b>	Displays options to change the system date, time, and so on.

## System Information screen details

You can use the **System Information** screen allows to view system properties such as Service Tag, system model, and BIOS version.

You can view the **System Information** screen by clicking **System Setup Main Menu** → **System BIOS** → **System Information**.

The **System Information** screen details are explained as follows:

### Example

Menu Item	Description
<b>System Model Name</b>	Displays the system model name.
<b>System BIOS Version</b>	Displays the BIOS version installed on the system.
<b>System Management Engine Version</b>	Displays the current revision of the Management Engine firmware.
<b>System Service Tag</b>	Displays the system Service Tag.

Menu Item	Description
<b>System Manufacturer</b>	Displays the name of the system manufacturer.
<b>System Manufacturer Contact Information</b>	Displays the contact information of the system manufacturer.
<b>System CPLD Version</b>	Displays the current revision of the system CPLD firmware.
<b>UEFI Compliance Version</b>	Displays the system firmware UEFI compliance level.

## Memory Settings screen details

You can use the **Memory Settings** screen to view all the memory settings as well as to enable or disable specific memory functions such as system memory testing and node interleaving.

You can view the **Memory Setting** screen by clicking **System Setup Main Menu** → **System BIOS** → **Memory Settings**.

The **Memory Settings** screen details are explained as follows:

### Example

Menu Item	Description
<b>System Memory Size</b>	Displays the amount of memory installed in the system.
<b>System Memory Type</b>	Displays the type of memory installed in the system.
<b>System Memory Speed</b>	Displays the system memory speed.
<b>System Memory Voltage</b>	Displays the system memory voltage.
<b>Video Memory</b>	Displays the amount of video memory.
<b>System Memory Testing</b>	Specifies whether system memory tests are run during system boot. Options are <b>Enabled</b> and <b>Disabled</b> . By default, the <b>System Memory Testing</b> option is set to <b>Disabled</b> .
<b>Memory Operating Mode</b>	Specifies the memory operating mode. The options available are <b>Optimizer Mode</b> , <b>Advanced ECC Mode</b> , <b>Mirror Mode</b> , <b>Spare Mode</b> , <b>Spare with Advanced ECC Mode</b> , and <b>Dell Fault Resilient Mode</b> . By default, the <b>Memory Operating Mode</b> option is set to <b>Optimizer Mode</b> .



**NOTE:** The **Memory Operating Mode** can have different defaults and available options based on the memory configuration of your system.

Menu Item	Description
	 <b>NOTE:</b> The <b>Dell Fault Resilient Mode</b> establishes an area of memory that is fault resilient. This mode can be used by an operating system that supports the feature to load critical applications or enables the operating system kernel to maximize system availability.
<b>Node Interleaving</b>	Specifies if Non-Uniform Memory architecture (NUMA) is supported. If this field is <b>Enabled</b> , memory interleaving is supported if a symmetric memory configuration is installed. If <b>Disabled</b> , the system supports NUMA (asymmetric) memory configurations. By default, <b>Node Interleaving</b> option is set to <b>Disabled</b> .
<b>Snoop Mode</b>	Specifies the Snoop Mode options. Snoop Mode options available are <b>Home Snoop</b> , <b>Early Snoop</b> , <b>Cluster on Die</b> . By default, the Snoop Mode option is set to <b>Early Snoop</b> . The field is only available when Node Interleaving is <b>Disabled</b> .

## Processor Settings screen details



You can use the **Processor Settings** screen to view the processor settings and perform specific functions such as enabling virtualization technology, hardware prefetcher, and logical processor idling.

You can view the **Processor Settings** screen by clicking **System Setup Main Menu** → **System BIOS** → **Processor Settings**.

The **Processor Settings** screen details are explained as follows:

### Example

Menu Item	Description
<b>Logical Processor</b>	Enables or disables the logical processors and displays the number of logical processors. If the <b>Logical Processor</b> option is set to <b>Enabled</b> , the BIOS displays all the logical processors. If this option is set to <b>Disabled</b> , the BIOS only displays one logical processor per core. By default, the <b>Logical Processor</b> option is set to <b>Enabled</b> .
<b>Alternate RTID (Requestor Transaction ID) Setting</b>	Enables you to allocate more RTIDs to the remote socket, thereby increasing cache performance between the sockets or easing work in normal mode for NUMA. By default, the <b>Alternate RTID (Requestor Transaction ID) Setting</b> is set to <b>Disabled</b> .
<b>Virtualization Technology</b>	Enables or disables the additional hardware capabilities provided for virtualization. By default, the <b>Virtualization Technology</b> option is set to <b>Enabled</b> .
<b>Address Translation Service (ATS)</b>	Defines the Address Translation Cache (ATC) for devices to cache the DMA transactions. This field provides an interface to a chipset's Address Translation and Protection Table to translate DMA addresses to host addresses. By default, the option is set to <b>Enabled</b> .
<b>Adjacent Cache Line Prefetch</b>	Optimizes the system for applications that require high utilization of sequential memory access. By default, the <b>Adjacent Cache Line Prefetch</b> option is set to <b>Enabled</b> . You can disable this option for applications that require high utilization of random memory access.
<b>Hardware Prefetcher</b>	Enables or disables the hardware prefetcher. By default, the <b>Hardware Prefetcher</b> option is set to <b>Enabled</b> .

Menu Item	Description
<b>DCU Streamer Prefetcher</b>	Allows you to enable or disable the Data Cache Unit (DCU) streamer prefetcher. By default, the <b>DCU Streamer Prefetcher</b> option is set to <b>Enabled</b> .
<b>DCU IP Prefetcher</b>	Enables or disables the Data Cache Unit (DCU) IP prefetcher. By default, the <b>DCU IP Prefetcher</b> option is set to <b>Enabled</b> .
<b>Execute Disable</b>	Enables or disables the execute disable memory protection technology. By default, the <b>Execute Disable</b> option is set to <b>Enabled</b> .
<b>Logical Processor Idling</b>	Enables or disables the operating system capability to put logical processors in the idling state in order to reduce power consumption. By default, the option is set to <b>Disabled</b> .
<b>Configurable TDP</b>	Allows reconfiguration of Thermal Design Power (TDP) to lower levels. TDP refers to the maximum amount of power the cooling system is required to dissipate.
<b>X2Apic Mode</b>	Enables or disables the X2Apic mode.
<b>Dell Controlled Turbo</b>	 <b>NOTE:</b> Depending on the number of installed CPUs, there may be up to four processor listings.  Controls the turbo engagement. Enable this option only when <b>System Profile</b> is set to <b>Performance</b> .
<b>Number of Cores per Processor</b>	Controls the number of enabled cores in each processor. By default, the <b>Number of Cores per Processor</b> option is set to <b>All</b> .
<b>Processor 64-bit Support</b>	Specifies if the processor(s) support 64-bit extensions.
<b>Processor Core Speed</b>	Displays the maximum core frequency of the processor.
<b>Processor 1</b>	 <b>NOTE:</b> Depending on the number of installed CPUs, there may be up to four processor listings. The following settings are displayed for each processor installed in the system.
<b>Family-Model-Stepping</b>	Displays the family, model and stepping of the processor as defined by Intel.
<b>Brand</b>	Displays the brand name reported by the processor.
<b>Level 2 Cache</b>	Displays the total L2 cache.
<b>Level 3 Cache</b>	Displays the total L3 cache.
<b>Number of Cores</b>	Displays the number of cores per processor.

## SATA Settings screen details

You can use the **SATA Settings** screen to view the SATA settings of SATA devices and enable RAID on your system.

You can view the **SATA Settings** screen by clicking **System Setup Main Menu** → **System BIOS** → **SATA Settings**.

The **SATA Settings** screen details are explained below.

### Example

Menu Item	Description
<b>Embedded SATA</b>	Enables the embedded SATA to be set to <b>Off</b> , <b>ATA</b> , <b>AHCI</b> , or <b>RAID</b> modes. By default, the <b>Embedded SATA</b> option is set to <b>AHCI</b> .
<b>Security Freeze Lock</b>	Sends Security Freeze Lock command to the Embedded SATA drives during POST. This option is only applicable to ATA and AHCI mode.
<b>Write Cache</b>	Enables or disables the command for Embedded SATA drives during POST.
<b>Port A</b>	Sets the drive type of the selected device. For <b>Embedded SATA settings</b> in <b>ATA</b> mode, set this field to <b>Auto</b> to enable BIOS support. Set it to <b>OFF</b> to turn off BIOS support. For <b>AHCI</b> mode or <b>RAID</b> mode, BIOS always enables support.
<b>Model</b>	Displays the drive model of the selected device.
<b>Drive Type</b>	Displays the type of drive attached to the SATA port.
<b>Capacity</b>	Displays the total capacity of the hard drive. The field is undefined for removable media devices such as optical drives.
<b>Port B</b>	Sets the drive type of the selected device. For <b>Embedded SATA settings</b> in <b>ATA</b> mode, set this field to <b>Auto</b> to enable BIOS support. Set it to <b>OFF</b> to turn off BIOS support. For <b>AHCI</b> mode or <b>RAID</b> mode, BIOS always enables support.
<b>Model</b>	Displays the drive model of the selected device.
<b>Drive Type</b>	Displays the type of drive attached to the SATA port.
<b>Capacity</b>	Displays the total capacity of the hard drive. The field is undefined for removable media devices such as optical drives.
<b>Port C</b>	Sets the drive type of the selected device. For <b>Embedded SATA settings</b> in <b>ATA</b> mode, set this field to <b>Auto</b> to enable BIOS support. Set it to <b>OFF</b> to turn off BIOS support. For <b>AHCI</b> mode or <b>RAID</b> mode, BIOS always enables support.
<b>Model</b>	Displays the drive model of the selected device.
<b>Drive Type</b>	Displays the type of drive attached to the SATA port.

Menu Item	Description
<b>Capacity</b>	Displays the total capacity of the hard drive. The field is undefined for removable media devices such as optical drives.
<b>Port D</b>	Sets the drive type of the selected device. For <b>Embedded SATA settings</b> in <b>ATA</b> mode, set this field to <b>Auto</b> to enable BIOS support. Set it to <b>OFF</b> to turn off BIOS support. For <b>AHCI</b> mode or <b>RAID</b> mode, BIOS always enables support.
<b>Model</b>	Displays the drive model of the selected device.
<b>Drive Type</b>	Displays the type of drive attached to the SATA port.
<b>Capacity</b>	Displays the total capacity of the hard drive. The field is undefined for removable media devices such as optical drives.
<b>Port E</b>	Sets the drive type of the selected device. For <b>Embedded SATA settings</b> in <b>ATA</b> mode, set this field to <b>Auto</b> to enable BIOS support. Set it to <b>OFF</b> to turn off BIOS support. For <b>AHCI</b> mode or <b>RAID</b> mode, BIOS always enables support.
<b>Model</b>	Displays the drive model of the selected device.
<b>Drive Type</b>	Displays the type of drive attached to the SATA port.
<b>Capacity</b>	Displays the total capacity of the hard drive. The field is undefined for removable media devices such as optical drives.
<b>Port F</b>	Sets the drive type of the selected device. For <b>Embedded SATA settings</b> in <b>ATA</b> mode, set this field to <b>Auto</b> to enable BIOS support. Set it to <b>OFF</b> to turn off BIOS support. For <b>AHCI</b> mode or <b>RAID</b> mode, BIOS always enables support.
<b>Model</b>	Displays the drive model of the selected device.
<b>Drive Type</b>	Displays the type of drive attached to the SATA port.
<b>Capacity</b>	Displays the total capacity of the hard drive. The field is undefined for removable media devices such as optical drives.
<b>Port G</b>	Sets the drive type of the selected device. For <b>Embedded SATA settings</b> in <b>ATA</b> mode, set this field to <b>Auto</b> to enable BIOS support. Set it to <b>OFF</b> to turn off BIOS support. For <b>AHCI</b> mode or <b>RAID</b> mode, BIOS always enables support.
<b>Model</b>	Displays the drive model of the selected device.
<b>Drive Type</b>	Displays the type of drive attached to the SATA port.
<b>Capacity</b>	Displays the total capacity of the hard drive. The field is undefined for removable media devices such as optical drives.

Menu Item	Description
<b>Port H</b>	Sets the drive type of the selected device. For <b>Embedded SATA settings</b> in <b>ATA</b> mode, set this field to <b>Auto</b> to enable BIOS support. Set it to <b>OFF</b> to turn off BIOS support. For <b>AHCI</b> mode or <b>RAID</b> mode, BIOS always enables support.
<b>Model</b>	Displays the drive model of the selected device.
<b>Drive Type</b>	Displays the type of drive attached to the SATA port.
<b>Capacity</b>	Displays the total capacity of the hard drive. The field is undefined for removable media devices such as optical drives.
<b>Port I</b>	Sets the drive type of the selected device. For <b>Embedded SATA settings</b> in <b>ATA</b> mode, set this field to <b>Auto</b> to enable BIOS support. Set it to <b>OFF</b> to turn off BIOS support. For <b>AHCI</b> mode or <b>RAID</b> mode, BIOS always enables support.
<b>Model</b>	Displays the drive model of the selected device.
<b>Drive Type</b>	Displays the type of drive attached to the SATA port.
<b>Capacity</b>	Displays the total capacity of the hard drive. The field is undefined for removable media devices such as optical drives.
<b>Port J</b>	Sets the drive type of the selected device. For <b>Embedded SATA settings</b> in <b>ATA</b> mode, set this field to <b>Auto</b> to enable BIOS support. Set it to <b>OFF</b> to turn off BIOS support. For <b>AHCI</b> mode or <b>RAID</b> mode, BIOS always enables support.
<b>Model</b>	Displays the drive model of the selected device.
<b>Drive Type</b>	Displays the type of drive attached to the SATA port.
<b>Capacity</b>	Displays the total capacity of the hard drive. The field is undefined for removable media devices such as optical drives.

## Boot Settings screen details

You can use the **Boot Settings** screen to set the Boot mode to either **BIOS** or **UEFI**. It also allows you to specify the boot order.

You can view the **Boot Settings** screen by clicking **System Setup Main Menu** → **System BIOS** → **Boot Settings**.

The **Boot Settings** screen details are explained as follows:

### Example

Menu Item	Description
<b>Boot Mode</b>	Enables you to set the boot mode of the system.
	 <b>CAUTION: Switching the boot mode may prevent the system from booting if the operating system is not installed in the same boot mode.</b>

Menu Item	Description
	 <b>NOTE:</b> Setting this field to <b>UEFI</b> disables <b>BIOS Boot Settings</b> menu. Setting this field to <b>BIOS</b> disables the <b>UEFI Boot Settings</b> menu.  If the operating system supports UEFI, you can set this option to <b>UEFI</b> . Setting this field to <b>BIOS</b> allows compatibility with non-UEFI operating systems. By default, the <b>Boot Mode</b> option is set to <b>BIOS</b> .
<b>Boot Sequence Retry</b>	Enables or disables the boot sequence retry feature. If this field is enabled and the system fails to boot, the system reattempts the boot sequence after 30 seconds. By default, the <b>Boot Sequence Retry</b> option is set to <b>Enabled</b> .
<b>Hard Disk Failover</b>	Specifies which devices in the <b>Hard-Disk Drive Sequence</b> are attempted in the boot sequence. When the option is <b>Disabled</b> , only the first hard disk device in the list is attempted to boot. When set to <b>Enabled</b> , all hard disk devices are attempted in order, as listed in the <b>Hard-Disk Drive Sequence</b> . This option is not enabled for UEFI Boot Mode.
<b>Boot Options Settings</b>	Configures the boot sequence and the boot devices.

## Network Settings screen details

You can use the **Network Settings** screen to modify PXE device settings. Network Settings are only available in UEFI boot mode. BIOS does not control network settings in the BIOS boot mode. For BIOS boot mode, the network settings are handled by the network controllers option ROM.

You can view the **Network Settings** screen by clicking **System Setup Main Menu** → **System BIOS** → **Network Settings**.

The **Network Settings** screen details are explained as follows:

### Example

Menu Item	Description
<b>PXE Device n (n = 1 to 4)</b>	Enables or disables the device. When enabled, a UEFI boot option is created for the device.
<b>PXE Device n Settings (n = 1 to 4)</b>	Allows you to control the configuration of the PXE device.

## Integrated Devices screen details



**Integrated Devices** screen allows you to view and configure the settings of all integrated devices including the video controller, integrated RAID controller, and the USB ports.

In the **System Setup Main Menu**, click **System BIOS** → **Integrated Devices**.

The **Integrated Devices** screen details are explained below.



## Example

Menu Item	Description
<b>USB 3.0 Setting</b>	Allows you to enable or disable the USB 3.0 support. Enable this option only if your operating system supports USB 3.0. Disabling this allows devices to operate at USB 2.0 speed. USB 3.0 is disabled by default.
<b>User Accessible USB Ports</b>	<p>Allows you to enable or disable the USB ports. Selecting <b>Only Back Ports On</b> disables the front USB ports, selecting <b>All Ports Off</b> disables all USB ports. The USB keyboard and mouse operates during boot process in certain operating systems. After the boot process is complete, the USB keyboard and mouse does not work if the ports are disabled.</p> <p> <b>NOTE:</b> Selecting <b>Only Back Ports On</b> and <b>All Ports Off</b> will disable the USB management port and also restrict access to iDRAC features.</p>
<b>Internal USB Port</b>	Allows you to enable or disable the internal USB port. By default, the <b>Internal USB Port</b> option is set to <b>Enabled</b> .
<b>Embedded NIC1 and NIC2</b>	<p> <b>NOTE:</b> The Embedded NIC1 and NIC2 option is only available on systems that do not have <b>Integrated Network Card 1</b>.</p> <p>Allows you to enable or disable the Embedded NIC1 and NIC2. If set to <b>Disabled</b>, the NIC may still be available for shared network access by the embedded management controller. The embedded NIC1 and NIC2 option is only available on systems that do not have NDCs. This option is mutually exclusive with the Integrated Network Card 1 option. Configure this function using the NIC management utilities of the system.</p>
<b>I/OAT DMA Engine</b>	Allows you to enable or disable the I/OAT option. Enable only if the hardware and software supports the feature.
<b>Embedded Video Controller</b>	Allows you to enable or disable the <b>Embedded Video Controller</b> . By default, the embedded video controller is <b>Enabled</b> . If the Embedded Video Controller is the only display capability in the system (that is, no add-in graphics card is installed), then the Embedded Video Controller is automatically used as the primary display even if the Embedded Video Controller setting is <b>Disabled</b> .
<b>Current State of Embedded Video Controller</b>	Displays the current state of the Embedded Video Controller. <b>Current State of Embedded Video Controller</b> is a read only field, indicating the current state for the Embedded Video Controller.
<b>SR-IOV Global Enable</b>	Allows you to enable or disable the BIOS configuration of Single Root I/O Virtualization (SR-IOV) devices. By default, the <b>SR-IOV Global Enable</b> option is set to <b>Disabled</b> .
<b>OS Watchdog Timer</b>	If your system stops responding, this watchdog timer aids in the recovery of your operating system. When this field is set to <b>Enabled</b> , the operating system is allowed to initialize the timer. When is set to <b>Disabled</b> (the default), the timer will have no effect on the system.
<b>Memory Mapped I/O above 4GB</b>	Allows you to enable support for PCIe devices that require large amounts of memory. By default, the option is set to <b>Enabled</b> .



Menu Item	Description
<b>Slot Disablement</b>	Allows you to enable or disable available PCIe slots on your system. The <b>Slot Disablement</b> feature controls the configuration of PCIe cards installed in the specified slot. Slot disablement must be used only when the installed peripheral card is preventing booting into the operating system or causing delays in system startup. If the slot is disabled, both the Option ROM and UEFI driver are disabled.

## Serial Communication screen details

You can use the **Serial Communication** screen to view the properties of the serial communication port. You can view the **Serial Communication** screen by clicking **System Setup Main Menu** → **System BIOS** → **Serial Communication**.

The **Serial Communication** screen details are explained below.

### Example

Menu Item	Description
<b>Serial Communication</b>	Selects serial communication devices (Serial Device 1 and Serial Device 2) in the BIOS. BIOS console redirection can also be enabled and the port address can be specified. By default, <b>Serial Communication</b> option is set to <b>Auto</b> .
<b>Serial Port Address</b>	Enables you to set the port address for serial devices. By default, the <b>Serial Port Address</b> option is set to <b>Serial Device 1=COM2, Serial Device 2=COM1</b> .   <b>NOTE:</b> Only Serial Device 2 can be used for Serial Over LAN (SOL). To use console redirection by SOL, configure the same port address for console redirection and the serial device.
<b>External Serial Connector</b>	Enables you to associate the external serial connector to serial device 1, serial device 2, or remote access device. By default, the <b>External Serial Connector</b> option is set to <b>Serial Device1</b> .   <b>NOTE:</b> Only Serial Device 2 can be used for SOL. To use console redirection by SOL, configure the same port address for console redirection and the serial device.
<b>Failsafe Baud Rate</b>	Displays the failsafe baud rate for console redirection. The BIOS attempts to determine the baud rate automatically. This failsafe baud rate is used only if the attempt fails and the value must not be changed. By default, the <b>Failsafe Baud Rate</b> option is set to <b>115200</b> .
<b>Remote Terminal Type</b>	Sets the remote console terminal type. By default, the <b>Remote Terminal Type</b> option is set to <b>VT 100/VT 220</b> .
<b>Redirection After Boot</b>	Enables or disables the BIOS console redirection when the operating system is loaded. By default, the <b>Redirection After Boot</b> option is set to <b>Enabled</b> .

## System Profile Settings screen details



You can use the **System Profile Settings** screen to enable specific system performance settings such as power management.

You can view the **System Profile Settings** screen by clicking **System Setup Main Menu** → **System BIOS** → **System Profile Settings**.

The **System Profile Settings** screen details are explained as follows:

**Example**

Menu Item	Description
<b>System Profile</b>	<p>Sets the system profile. If you set the <b>System Profile</b> option to a mode other than <b>Custom</b>, the BIOS automatically sets the rest of the options. You can only change the rest of the options if the mode is set to <b>Custom</b>. By default, the <b>System Profile</b> option is set to <b>Performance Per Watt Optimized (DAPC)</b>. DAPC is Dell Active Power Controller.</p> <p> <b>NOTE:</b> The following parameters are available only when the <b>System Profile</b> is set to <b>Custom</b>.</p>
<b>CPU Power Management</b>	Sets the CPU power management. By default, the <b>CPU Power Management</b> option is set to <b>System DBPM (DAPC)</b> . DBPM is Demand-Based Power Management.
<b>Memory Frequency</b>	Sets the speed of the system memory. You can select <b>Maximum Performance</b> , <b>Maximum Reliability</b> , or a specific speed.
<b>Turbo Boost</b>	Enables or disables the processor to operate in turbo boost mode. By default, the <b>Turbo Boost</b> option is set to <b>Enabled</b> .
<b>Energy Efficient Turbo</b>	<p>Enables or disables the <b>Energy Efficient Turbo</b>.</p> <p>Energy Efficient Turbo (EET) is a mode of operation where a processor's core frequency is adjusted within the turbo range based on workload.</p>
<b>C1E</b>	Enables or disables the processor to switch to a minimum performance state when it is idle. By default, the <b>C1E</b> option is set to <b>Enabled</b> .
<b>C States</b>	Enables or disables the processor to operate in all available power states. By default, the <b>C States</b> option is set to <b>Enabled</b> .
<b>Collaborative CPU Performance Control</b>	Enables or disables the CPU power management. When set to <b>Enabled</b> , the CPU power management is controlled by the OS DBPM and the System DBPM (DAPC). By default, the option is set to <b>Disabled</b> .
<b>Memory Patrol Scrub</b>	Sets the memory patrol scrub frequency. By default, the <b>Memory Patrol Scrub</b> option is set to <b>Standard</b> .
<b>Memory Refresh Rate</b>	Sets the memory refresh rate to either 1x or 2x. By default, the <b>Memory Refresh Rate</b> option is set to <b>1x</b> .
<b>Uncore Frequency</b>	<p>Selects the <b>Processor Uncore Frequency</b>.</p> <p>Dynamic mode allows the processor to optimize power resources across the cores and uncore during runtime. The optimization of the uncore frequency to either save power or optimize performance is influenced by the setting of the <b>Energy Efficiency Policy</b>.</p>
<b>Energy Efficient Policy</b>	<p>Selects the <b>Energy Efficient Policy</b>.</p> <p>The CPU uses the setting to manipulate the internal behavior of the processor and determines whether to target higher performance or better power savings.</p>

Menu Item	Description
<b>Number of Turbo Boot Enabled Cores for Processor 1</b>	 <b>NOTE:</b> If there are two processors installed in the system, you see an entry for <b>Number of Turbo Boost Enabled Cores for Processor 2</b> . Controls the number of turbo boost enabled cores for processor 1. By default, the maximum number of cores is enabled.
<b>Monitor/Mwait</b>	Enables the Monitor/Mwait instructions in the processor. By default, the Monitor/Mwait option is set to <b>Enabled</b> for all system profiles, except <b>Custom</b> .   <b>NOTE:</b> This option can be disabled only if the <b>C States</b> option in <b>Custom</b> mode is disabled.   <b>NOTE:</b> When <b>C States</b> is enabled in <b>Custom</b> mode, changing the Monitor/Mwait setting does not impact system power/performance.



## System Security settings screen details

You can use the **System Security** screen to perform specific functions such as setting the system password, setup password, and disabling the power button.

You can view the **System Security** screen by clicking **System Setup Main Menu** → **System BIOS** → **System Security Settings**.

The **System Security Settings** screen details are explained as follows:

### Example

Menu Item	Description
<b>Intel AES-NI</b>	Improves the speed of applications by performing encryption and decryption using the Advanced Encryption Standard Instruction Set and is set to <b>Enabled</b> by default.
<b>System Password</b>	Sets the system password. This option is set to <b>Enabled</b> by default and is read-only if the password jumper is not installed in the system.
<b>Setup Password</b>	Sets the setup password. This option is read-only if the password jumper is not installed in the system.
<b>Password Status</b>	Locks the system password. By default, the <b>Password Status</b> option is set to <b>Unlocked</b> .
<b>TPM Security</b>	 <b>NOTE:</b> The TPM menu is available only when the TPM module is installed.  Allows you to control the reporting mode of the Trusted Platform Module (TPM). By default, the <b>TPM Security</b> option is set to <b>Off</b> . You can only modify the TPM Status, TPM Activation, and Intel TXT fields if the <b>TPM Status</b> field is set to either <b>On with Pre-boot Measurements</b> or <b>On without Pre-boot Measurements</b> .
<b>TPM Information</b>	Changes the operational state of the TPM. By default, the <b>TPM Activation</b> option is set to <b>No Change</b> .
<b>TPM Status</b>	Displays the TPM status.
<b>TPM Command</b>	 <b>CAUTION:</b> Clearing the TPM results in the loss of all keys in the TPM. The loss of TPM keys may affect booting to the operating system.

Menu Item	Description
	Clears all the contents of the TPM. By default, the <b>TPM Clear</b> option is set to <b>No</b> .
Intel TXT	Enables or disables the Intel Trusted Execution Technology (TXT). To enable <b>Intel TXT</b> , Virtualization Technology must be enabled and TPM Security must be <b>Enabled</b> with Pre-boot measurements. By default, the <b>Intel TXT</b> option is set to <b>Off</b> .
Power Button	Enables or disables the power button on the front of the system. By default, the <b>Power Button</b> option is set to <b>Enabled</b> .
NMI Button	Enables or disables the NMI button on the front of the system. By default, the <b>NMI Button</b> option is set to <b>Disabled</b> .
AC Power Recovery	Sets how the system reacts after AC power is restored to the system. By default, the <b>AC Power Recovery</b> option is set to <b>Last</b> .
AC Power Recovery Delay	Sets how the system supports staggering of power up after AC power is restored to the system. By default, the <b>AC Power Recovery Delay</b> option is set to <b>Immediate</b> .
User Defined Delay (60s to 240s)	Sets the <b>User Defined Delay</b> when the <b>User Defined</b> option for <b>AC Power Recovery Delay</b> is selected.
UEFI Variable Access	Provides varying degrees of securing UEFI variables. When set to <b>Standard</b> (the default) UEFI variables are accessible in the Operating System per the UEFI specification. When set to <b>Controlled</b> , selected UEFI variables are protected in the environment and new UEFI boot entries are forced to be at the end of the current boot order.
Secure Boot	Enables Secure Boot, where the BIOS authenticates each pre-boot image using the certificates in the Secure Boot Policy. Secure Boot is disabled by default.
Secure Boot Policy	When Secure Boot policy is <b>Standard</b> , the BIOS uses the system manufacturer's key and certificates to authenticate pre-boot images. When Secure Boot policy is <b>Custom</b> , the BIOS uses the user-defined key and certificates. Secure Boot policy is <b>Standard</b> by default.
Secure Boot Policy Summary	Views the list of certificates and hashes that secure boot uses to authenticated images.

### Secure Boot Custom Policy Settings

Secure Boot Custom Policy Settings is displayed only when **Secure Boot Policy** is set to **Custom**. In the **System Setup Main Menu**, click **System BIOS** → **System Security** → **Secure Boot Custom Policy Settings**.

The **Secure Boot Custom Policy Settings** screen details are explained as follows:

#### Example

Menu Item	Description
Platform Key	Imports, exports, deletes, or restores the platform key (PK).
Key Exchange Key Database	Allows you to import, export, delete, or restore entries in the Key Exchange Key (KEK) Database

Menu Item	Description
Authorized Signature Database	Imports, exports, deletes, or restores entries in the Authorized Signature Database (db).
Forbidden Signature Database	Imports, exports, deletes, or restores entries in the Forbidden Signature Database (dbx).



## Miscellaneous Settings screen details

You can use the **Miscellaneous Settings** screen to perform specific functions such as updating the asset tag, and changing the system date and time.

You can view the **Miscellaneous Settings** screen by clicking **System Setup Main Menu** → **System BIOS** → **Miscellaneous Settings**.

The **Miscellaneous Settings** screen details are explained as follows:

### Example

Menu Item	Description
System Time	Enables you to set the time on the system.
System Date	Enables you to set the date on the system.
Asset Tag	Displays the asset tag and enables you to modify it for security and tracking purposes.
Keyboard NumLock	Enables you to set whether the system boots with the NumLock enabled or disabled. By default the <b>Keyboard NumLock</b> is set to <b>On</b> .  <b>NOTE:</b> This option does not apply to 84-key keyboards.
F1/F2 Prompt on Error	Enables or disables the F1/F2 prompt on error. By default, <b>F1/F2 Prompt on Error</b> is set to <b>Enabled</b> . The F1/F2 prompt also includes keyboard errors.
Load Legacy Video Option ROM	Enables you to determine whether the system BIOS loads the legacy video (INT 10H) option ROM from the video controller. Selecting <b>Enabled</b> in the operating system does not support UEFI video output standards. This field is only for UEFI boot mode. You cannot set this to <b>Enabled</b> if <b>UEFI Secure Boot</b> mode is enabled.
In-System Characterization	This option enables or disables <b>In-System Characterization</b> . By default, <b>In-System Characterization</b> is set to <b>Disabled</b> . The two other options are <b>Enabled</b> and <b>Enabled - No Reboot</b> .  <b>NOTE:</b> The default setting for <b>In-System Characterization</b> is subject to change in future BIOS releases.  When enabled, In-System Characterization (ISC) executes during POST upon detecting relevant change(s) in system configuration to optimize system power and performance. ISC takes about 20 seconds to execute, and system reset is required for ISC results to be applied. The <b>Enabled - No Reboot</b> option executes ISC and continues without applying ISC results until the next time system reset occurs. The <b>Enabled</b> option executes ISC and forces an immediate system reset so that ISC

Menu Item	Description
	results can be applied. It takes the system longer to be ready due to the forced system reset. When disabled, ISC does not execute.

## About Boot Manager

**Boot Manager** enables you to add, delete, and arrange boot options. You can also access System Setup and boot options without restarting the system.

### Entering Boot Manager

The **Boot Manager** screen allows you to select boot options and diagnostic utilities.

1. Turn on or restart your system.
2. Press <F11> when you see the message <F11> = Boot Manager.  
If your operating system begins to load before you press <F11>, allow the system to finish booting, and then restart your system and try again.

### Boot Manager main menu

Menu Item	Description
<b>Continue Normal Boot</b>	The system attempts to boot to devices starting with the first item in the boot order. If the boot attempt fails, the system continues with the next item in the boot order until the boot is successful or no more boot options are found.
<b>One Shot Boot Menu</b>	Takes you to the boot menu where you can select a one time boot device to boot from.
<b>Launch System Setup</b>	Enables you to access the System Setup.
<b>Launch Lifecycle Controller</b>	Exits the Boot Manager and invokes the Lifecycle Controller program.
<b>System Utilities</b>	Launches system utilities menu such as system diagnostics and UEFI shell.

## Changing the boot order

You may have to change the boot order if you want to boot from a USB key or an optical drive.

### About this task

 **NOTE:** The instructions given below may vary if you have selected **BIOS** for **Boot Mode**.

#### Steps

1. In the **System Setup Main Menu**, click **System BIOS** → **Boot Settings**.
2. Click **Boot Option Settings** → **Boot Sequence**.
3. Use the arrow keys to select a boot device, and use the + and - keys to move the device down or up in the ordering.
4. Click **Exit**, click **Yes** to save the settings on exit.

# Choosing the system boot mode

System Setup enables you to specify the boot mode for installing your operating system:

- BIOS boot mode (the default) is the standard BIOS-level boot interface.
- UEFI boot mode is an enhanced 64-bit boot interface based on Unified Extensible Firmware Interface (UEFI) specifications that overlays the system BIOS.

You must select the boot mode in the **Boot Mode** field of the **Boot Settings** screen of System Setup. Once you specify the boot mode, the system boots in the specified boot mode and you then proceed to install your operating system from that mode. Thereafter, you must boot the system in the same boot mode (BIOS or UEFI) to access the installed operating system. Trying to boot the operating system from the other boot mode will cause the system to halt at startup.

 **NOTE:** Operating systems must be UEFI-compatible to be installed from the UEFI boot mode. DOS and 32-bit operating systems do not support UEFI and can only be installed from the BIOS boot mode.

 **NOTE:** For the latest information on supported operating systems, go to [dell.com/ossupport](http://dell.com/ossupport).

# Assigning a system and setup password

## Prerequisites

 **NOTE:** The password jumper enables or disables the System Password and Setup Password features. For more information about the password jumper settings, see [System board connectors](#).

You can assign a new **System Password** and **Setup Password** or change an existing **System Password** and **Setup Password** only when the password jumper setting is **enabled** and **Password Status** is **Unlocked**.

If the password jumper setting is disabled, the existing **System Password** and **Setup Password** are deleted and you need not provide the system password to boot the system.

## About this task

To assign a **System Password** and **Setup Password**, follow the steps below:

### Steps

1. To enter System Setup, press <F2> immediately after a power-on or reboot.
2. From the **System Setup Main Menu**, select **System BIOS** and press <Enter>. The **System BIOS** screen is displayed.
3. On the **System BIOS** screen, select **System Security** and press <Enter>. The **System Security** screen is displayed.
4. On the **System Security** screen, verify that **Password Status** is **Unlocked**.
5. Select **System Password**, enter your system password, and press <Enter> or <Tab>. Use the following guidelines to assign the system password:
  - A password can have up to 32 characters.
  - The password can contain the numbers 0 through 9.
  - Only the following special characters are allowed: space, ("), (+), (,), (-), (.), (/), (:), (@), (\), (!), (').

A message prompts you to re-enter the system password.



6. Re-enter the system password, and click **OK**.
7. Select **Setup Password**, enter your system password and press <Enter> or <Tab>. A message prompts you to re-enter the setup password.
8. Re-enter the setup password, and click **OK**.
9. Press <Esc> to return to the System BIOS screen. Press <Esc> again. A message prompts you to save the changes.



**NOTE:** Password protection does not take effect until the system reboots.

## Deleting or changing an existing system password and setup password

### Prerequisites







Ensure that the Password jumper is set to enabled and the **Password Status** is **Unlocked** before attempting to delete or change the existing System and/or Setup password. You cannot delete or change an existing System or Setup password if the **Password Status** is **Locked**.

### Steps

1. To enter System Setup, press <F2> immediately after a power on or restart.
2. From the **System Setup Main Menu**, select **System BIOS** and press <Enter>. The **System BIOS** screen is displayed.
3. On the **System BIOS Screen**, select **System Security** and press <Enter>. The **System Security** screen is displayed.
4. On the **System Security** screen, verify that **Password Status** is **Unlocked**.
5. Select **System Password**, alter or delete the existing system password and press <Enter> or <Tab>.
6. Select **Setup Password**, alter or delete the existing setup password and press <Enter> or <Tab>. If you change the System and Setup password a message prompts you to re-enter the new password. If you delete the System and Setup password, a message prompts you to confirm the deletion.
7. Press <Esc> to return to the System BIOS screen. Press <Esc> again, and a message prompts you to save the changes.

# Installing and removing system components

## Safety instructions

-  **WARNING:** Whenever you need to lift the system, get others to assist you. To avoid injury, do not attempt to lift the system by yourself.
-  **WARNING:** Opening or removing the system cover when the system is on may expose you to a risk of electric shock.
-  **CAUTION:** Do not operate the system without the cover for a duration exceeding five minutes.
-  **CAUTION:** Many repairs may only be done by a certified service technician. You should only perform troubleshooting and simple repairs as authorized in your product documentation, or as directed by the online or telephone service and support team. Damage due to servicing that is not authorized by Dell is not covered by your warranty. Read and follow the safety instructions that came with the product.
-  **NOTE:** It is recommended that you always use a static mat and static strap while working on components inside the system.
-  **NOTE:** To ensure proper operation and cooling, all bays in the system must be populated at all times with either a module or with a blank.

## Before working inside your system

1. Turn off the system, including any attached peripherals.
2. Disconnect the system from the electrical outlet and disconnect the peripherals.
3. If installed, remove the front bezel.  
For more information, see [Removing the front bezel](#).
4. Lay the system on its side.
5. Remove the system cover.  
For more information, see [Removing the system cover](#).

## After working inside your system

1. Install the system cover.  
For more information, see [Installing the system cover](#).
2. Place the system upright on its feet on a flat, stable surface.
3. Install the optional bezel.  
For more information, see [Installing the front bezel](#).

4. Reconnect the system to its electrical outlet and peripherals.
5. Turn the system on, including any attached peripherals.

## Recommended tools

You need the #2 Phillips screwdriver to perform the removal and installation procedures.

The following tools are required for assembling cables for a DC power supply unit (PSU):

- AMP 90871-1 hand-crimping tool or equivalent
- Tyco Electronics 58433-3 or equivalent
- Wire-stripper pliers capable of removing insulation from size 10 AWG solid or stranded, insulated copper wire

 **NOTE:** Use alpha wire part number 3080 or equivalent (65/30 stranding).

## Front bezel (optional)

### Installing the front bezel

1. Locate and remove the bezel keys.
2. Insert the bezel tabs into the bezel tab slots in the chassis.
3. Insert the bezel tabs into the slots on the chassis.
4. Press the release latch and push the bezel toward the system until the bezel locks into place.
5. Lock the bezel.

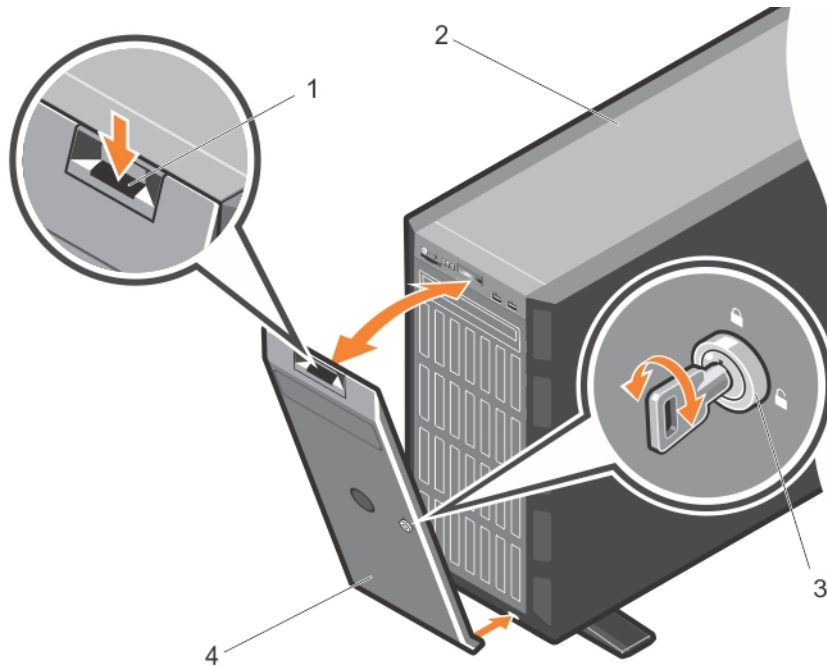

**Figure 8. Installing and removing the front bezel**

- |                  |           |
|------------------|-----------|
| 1. release latch | 2. system |
| 3. bezel key     | 4. bezel  |

## Removing the front bezel

1. Unlock the bezel using the bezel keys.
2. Press the release latch at the top of the bezel.
3. Pull the top end of the bezel away from the system.
4. Remove the bezel by unhooking the bezel tabs from the slots at the bottom of the system.

## System feet

The system feet provide stability to the system in the tower mode.

### Removing the system feet

#### Prerequisites

**NOTE:** It is recommended that you remove the system feet only when you are converting the system from the tower mode to the rack mode, or when you are replacing the system feet with the wheel assembly.

1. Ensure that you read the [Safety instructions](#).
2. Keep the #2 Phillips screwdriver ready.
3. Rotate the system feet inward.
4. Lay the system on its side on a flat, stable surface.

## Steps

Remove the screws securing the system feet to the base of the tower.

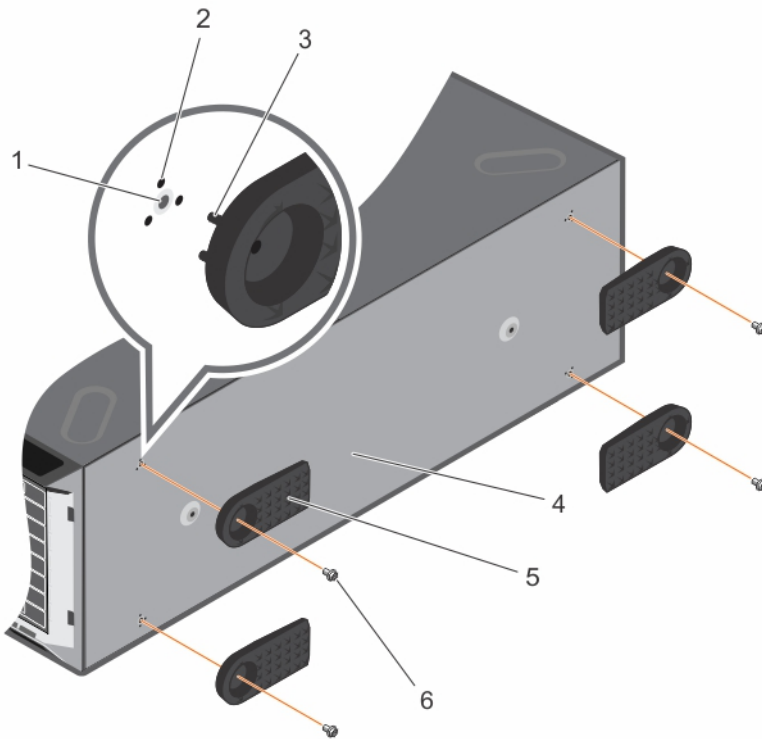

**Figure 9. Removing and installing the system feet**

- |                    |                      |
|--------------------|----------------------|
| 1. screw hole (4)  | 2. slot (12)         |
| 3. tab (12)        | 4. base of the tower |
| 5. system feet (4) | 6. screw (4)         |

## Installing the system feet

### Prerequisites

**△ CAUTION:** Installing the feet on a stand-alone tower system is necessary to provide a stable foundation for the system. Failure to install the feet poses the risk of having the system tip over, possibly causing bodily injury or damage to the system.

1. Ensure that you read the [Safety instructions](#).
2. Keep the #2 Phillips screwdriver ready.
3. Lay the system on its side on a flat, stable surface.

### Steps

1. Align the three tabs on the system feet with the three slots on the base of the chassis.
2. Secure the system feet to the base of the chassis by using the screws.

**Next steps**

Place the system upright on a flat, stable surface, and turn the system feet outward.

## Caster wheels (optional)—tower mode

Caster wheels provide mobility to the system in the tower mode.

Caster wheels consist of:

- Caster wheel units (front and back)
- Two screws for the caster wheel units

### Installing caster wheels

**Prerequisites**

1. Ensure that you read the [Safety instructions](#).
2. Keep the #2 Phillips screwdriver ready.
3. Lay the system on its side on a flat, stable surface with the base of the system extending off the edge of the surface.
4. If installed, remove the system feet. For more information, see [Removing the system feet](#).

**Steps**

1. Align the two retention hooks on the back wheel unit with the two slots on the base of the chassis, and insert the hooks into the slots.
2. Offset the back wheel slightly to the back of the system and secure the unit in place using a single screw.
3. Align the two retention hooks on the front wheel with the two slots on the base of the chassis, and insert the hooks into the slots.
4. Offset the front wheel slightly to the front and secure the unit in place using a screw.

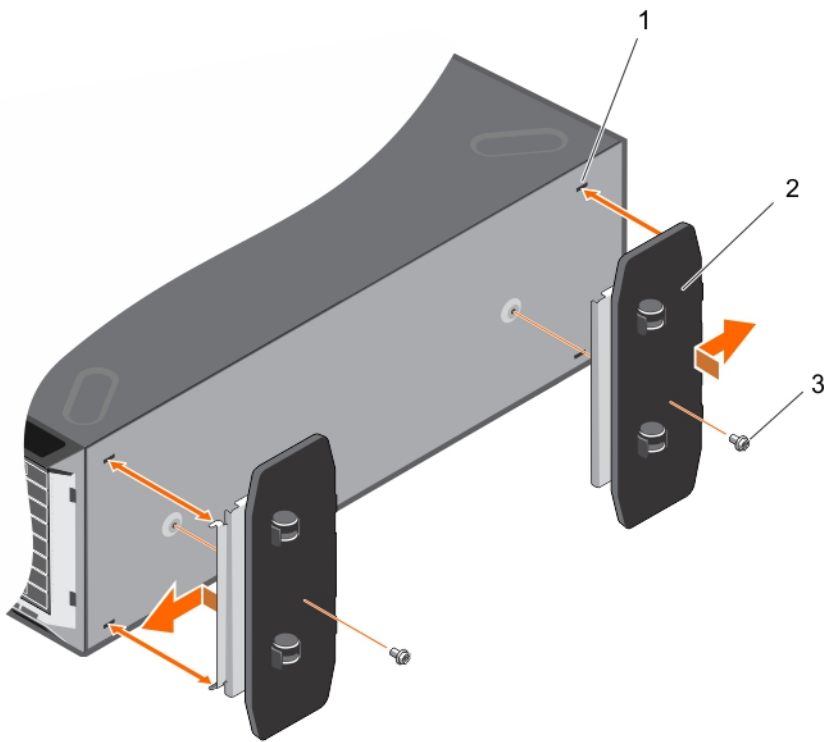

**Figure 10. Removing and installing caster wheels**

- |                                   |                            |
|-----------------------------------|----------------------------|
| 1. slots on base of the tower (4) | 2. wheel assembly unit (2) |
| 3. screw (2)                      |                            |

## Removing caster wheels

### Prerequisites

1. Ensure that you read the [Safety instructions](#).
2. Keep the #2 Phillips screwdriver ready.
3. Lay the system on a flat, stable surface with the wheels extending beyond the edge of the surface.

### Steps

1. Remove the screw securing the front wheel unit to the base of the chassis.
2. Offset the front wheel unit slightly to the back of the system to release the retention hooks, and pull out the front wheel unit.
3. Remove the screw securing the back wheel unit to the base of the chassis.
4. Offset the back wheel unit slightly to the front of the system to release the retention hooks, and pull out the back wheel unit.

# Removing the system cover

## Prerequisites

1. Ensure that you read the [Safety instructions](#).
2. Turn off the system, including any attached peripherals.
3. Disconnect the system from the electrical outlet and disconnect the peripherals.
4. Remove the optional front bezel.
5. Lay the system on a flat, stable surface.

## Steps

1. Turn the latch release lock to the unlock position.
2. Press the cover release latch and remove the system cover.

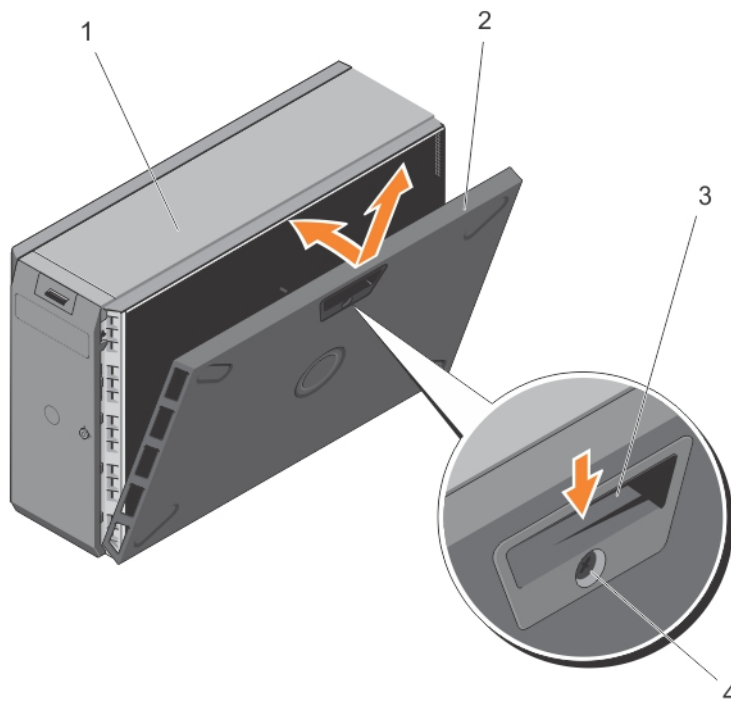

Figure 11. Removing and installing the system cover

- |                        |                             |
|------------------------|-----------------------------|
| 1. system              | 2. system cover             |
| 3. cover release latch | 4. cover latch release lock |

# Installing the system cover

## Prerequisites

Ensure that you read the [Safety instructions](#).



### Steps

1. Align the slots of the system cover with the tabs on the chassis.
2. Press the cover release latch, and push the cover toward the chassis until the latch locks into place.
3. Turn the latch release lock to the locked position

### Next steps

1. Place the system upright on its feet on a flat, stable surface.
2. If applicable, install the front bezel. For more information, see [Installing the front bezel](#).
3. Reconnect the system to its electrical outlet.
4. Turn the system on, and reconnect any attached peripherals.

## Inside the system



**CAUTION:** Many repairs may only be done by a certified service technician. You should only perform troubleshooting and simple repairs as authorized in your product documentation, or as directed by the online or telephone service and support team. Damage due to servicing that is not authorized by Dell is not covered by your warranty. Read and follow the safety instructions that came with the product.

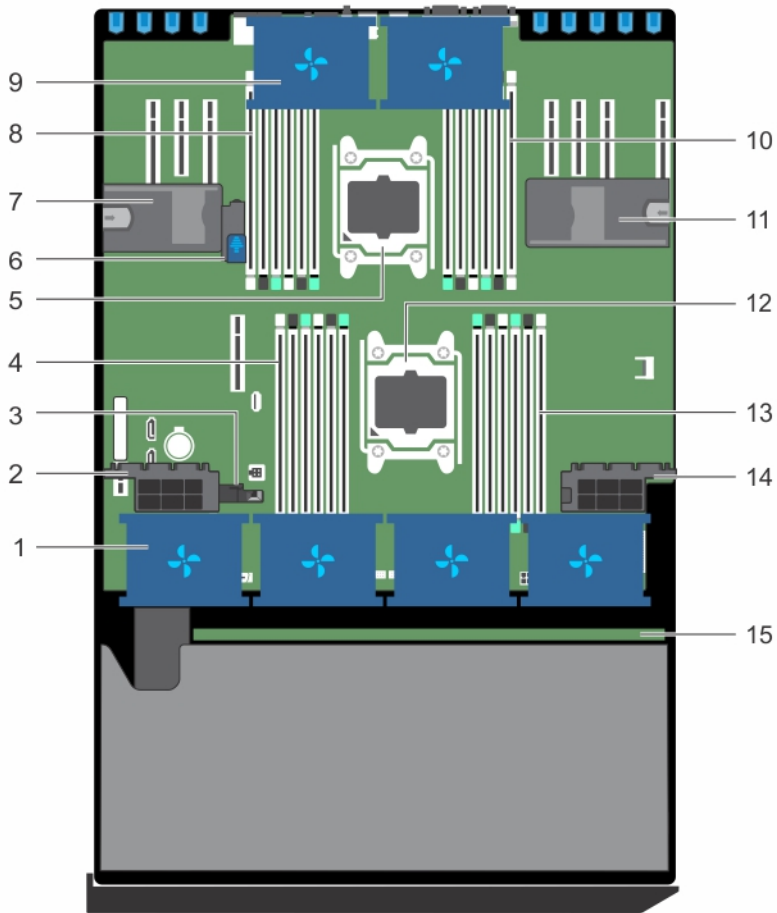

**Figure 12. Inside the system**

- |   |                           |
|---|---------------------------|
| 1. cooling fan in the cooling fan assembly (optional) | 2. expansion card holder  |
| 3. guide to align the cooling shroud                  | 4. DIMM slots (6)         |
| 5. processor 2  | 6. system-board holder    |
| 7. expansion card holder                              | 8. DIMM slots (6)         |
| 9. cooling fan in the cooling shroud (2)              | 10. DIMM slots (6)        |
| 11. expansion card holder                             | 12. processor 1           |
| 13. DIMM slots (6)                                    | 14. expansion card holder |
| 15. hard-drive backplane                              |                           |

## Cooling shroud

## Removing the cooling shroud

### Prerequisites

⚠ **CAUTION:** Many repairs may only be done by a certified service technician. You should only perform troubleshooting and simple repairs as authorized in your product documentation, or as directed by the online or telephone service and support team. Damage due to servicing that is not authorized by Dell is not covered by your warranty. Read and follow the safety instructions that came with the product.

⚠ **CAUTION:** Never operate your system with the cooling shroud removed. The system may get overheated quickly, resulting in shutdown of the system and loss of data.

1. Ensure that you read the [Safety instructions](#).
2. Follow the procedure listed in [Before working inside your system](#).
3. If required, remove the two cooling fans. For more information, see [Removing a cooling fan](#).

### Steps

Pull the cooling shroud release tab, and holding the touch points at the center of the cooling shroud, lift the shroud from the system.

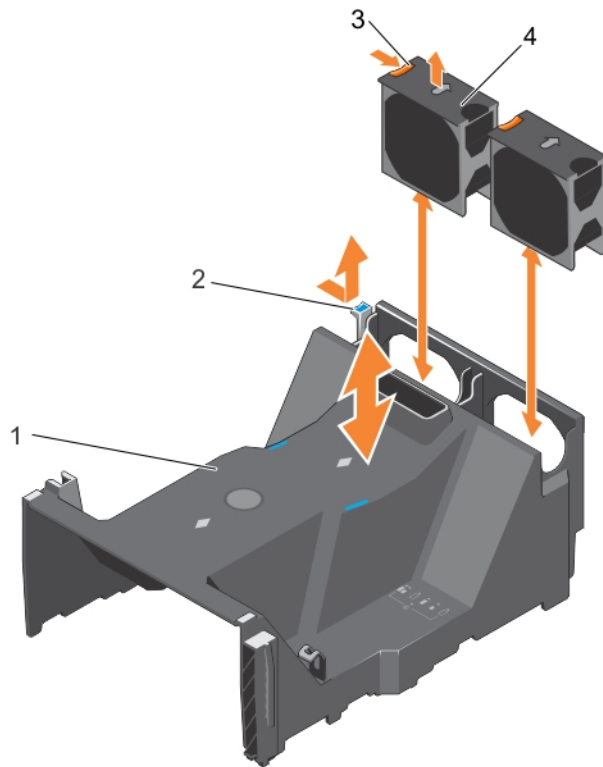

Figure 13. Removing and installing the cooling shroud

1. cooling shroud

2. cooling shroud release tab

3. fan release tab

4. cooling fan

## Installing the cooling shroud

### Prerequisites

 **CAUTION:** Many repairs may only be done by a certified service technician. You should only perform troubleshooting and simple repairs as authorized in your product documentation, or as directed by the online or telephone service and support team. Damage due to servicing that is not authorized by Dell is not covered by your warranty. Read and follow the safety instructions that came with the product.

 **NOTE:** For proper seating of the cooling shroud in the system chassis, ensure that the cables inside the system are routed along the chassis wall and secured using the cable securing bracket.

Ensure that you read the [Safety instructions](#).

### Steps

1. Align the tabs on the cooling shroud with the securing slots on the chassis.
2. Press the cooling shroud into the chassis until it is firmly seated.
3. If removed, install the cooling fans in the cooling shroud.

### Next steps

Follow the procedure listed in [After working inside your system](#).

## Cooling fans

There are two cooling fans on the cooling shroud and an optional cooling fan assembly that houses four cooling fans, on your system.

 **NOTE:** Each fan is listed in the system's management software, referenced by the respective fan number. If there is a problem with a particular fan, you can easily identify and replace the proper fan by noting the fan numbers on the cooling fan assembly.

## Removing a cooling fan

### Prerequisites

1. Ensure that you read the [Safety instructions](#).
2. Follow the procedure listed in [Before working inside your system](#).

 **WARNING:** Opening or removing the system cover when the system is on may expose you to a risk of electric shock. Exercise utmost care while removing or installing cooling fans.

 **CAUTION:** Many repairs may only be done by a certified service technician. You should only perform troubleshooting and simple repairs as authorized in your product documentation, or as directed by the online or telephone service and support team. Damage due to servicing that is not authorized by Dell is not covered by your warranty. Read and follow the safety instructions that came with the product.

 **CAUTION:** The cooling fans are hot-swappable. To maintain proper cooling while the system is on, replace only one fan at a time.

 **CAUTION:** Do not operate the system with the cover removed for a duration exceeding five minutes.

 **NOTE:** The procedure for removing an individual fan from the cooling-fan assembly and the cooling shroud is identical.

### Steps

Press the fan release tab and lift the cooling fan out of the cooling-fan assembly.

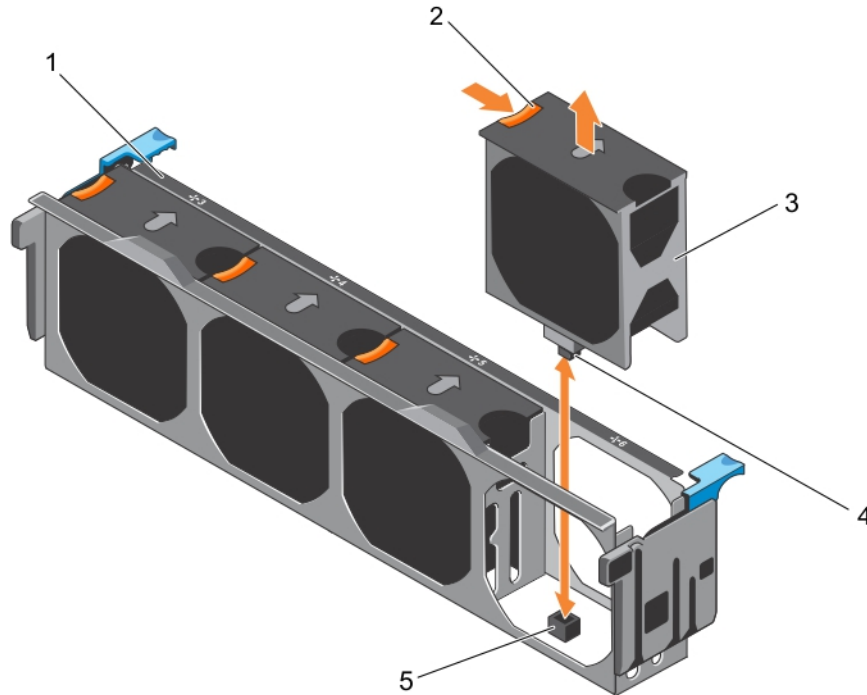



**Figure 14. Removing and installing a cooling fan from the cooling-fan assembly**

- a. cooling-fan assembly
- b. fan release tab
- c. cooling fan
- d. plug
- e. cooling fan connector on the system board

## Installing a cooling fan

### Prerequisites

 **CAUTION:** Many repairs may only be done by a certified service technician. You should only perform troubleshooting and simple repairs as authorized in your product documentation, or as directed by the online or telephone service and support team. Damage due to servicing that is not authorized by Dell is not covered by your warranty. Read and follow the safety instructions that came with the product.

 **NOTE:** The procedure for installing an individual fan in the cooling-fan assembly and the cooling shroud is identical.

Ensure that you read the [Safety instructions](#).

### Steps

1. Align the plug at the base of the cooling fan with the connector on the system board.
2. Slide the cooling fan into the securing slots until the plug locks into place.

### Next steps

Follow the procedure listed in [After working inside your system](#).

## Cooling-fan assembly (optional)

### Removing the cooling-fan assembly (optional)

#### Prerequisites

**⚠ CAUTION:** Many repairs may only be done by a certified service technician. You should only perform troubleshooting and simple repairs as authorized in your product documentation, or as directed by the online or telephone service and support team. Damage due to servicing that is not authorized by Dell is not covered by your warranty. Read and follow the safety instructions that came with the product.

1. Ensure that you read the [Safety instructions](#).
2. Follow the procedure listed in [Before working inside your system](#).

### Steps

1. Unlock the cooling-fan assembly from the chassis by lifting the release levers up.
2. Lift the cooling-fan assembly out of the chassis.

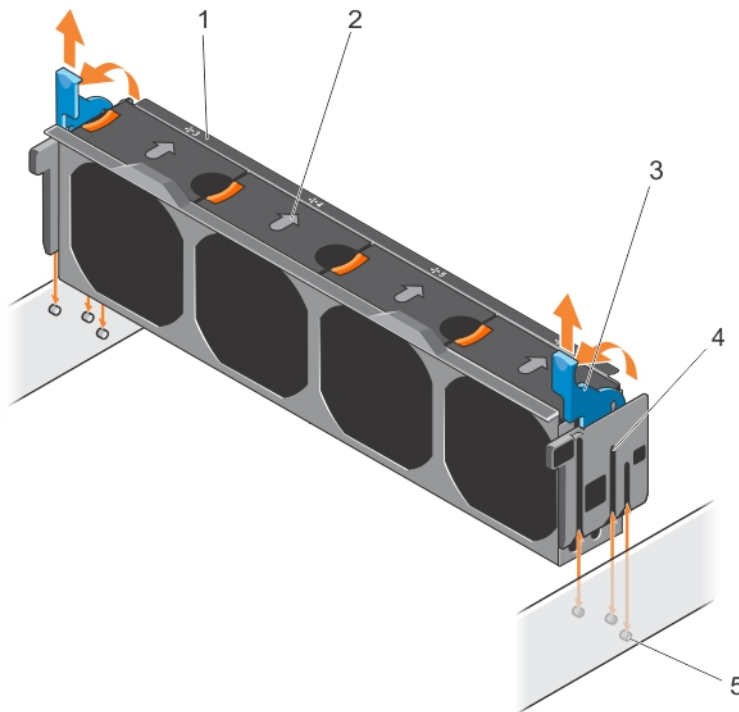

**Figure 15. Removing and installing the cooling-fan assembly**

1. cooling-fan assembly
2. cooling fan (4)

3. release lever (2)
5. guide pin (3)

4. slot (3)

## Installing the cooling-fan assembly (optional)

### Prerequisites

 **CAUTION:** Many repairs may only be done by a certified service technician. You should only perform troubleshooting and simple repairs as authorized in your product documentation, or as directed by the online or telephone service and support team. Damage due to servicing that is not authorized by Dell is not covered by your warranty. Read and follow the safety instructions that came with the product.

 **CAUTION:** Ensure that the cables are correctly installed and retained by cable retention bracket before installing the cooling-fan assembly. Incorrectly installed cables may get damaged.

Ensure that you read the [Safety instructions](#).

### Steps

1. Align the slots on the cooling-fan assembly with the guide pins on the chassis side walls.
2. Slide the cooling-fan assembly into the chassis.
3. Lock the cooling-fan assembly into the chassis by pressing the release levers down.

### Next steps

Follow the procedure listed in [After working inside your system](#).

## System memory

Your system supports DDR4 registered DIMMs (RDIMMs), and load reduced DIMMs (LRDIMMs). It supports DDR4 voltage specifications.

 **NOTE:** MT/s indicates DIMM speed in MegaTransfers per second.

Memory bus operating frequency can be 2133 MT/s, 1866 MT/s, 1600 MT/s, or 1333 MT/s depending on:

- DIMM type ( RDIMM or LRDIMM)
- Number of DIMMs populated per channel
- System profile selected (for example, Performance Optimized, Custom, or Dense Configuration Optimized)
- Maximum supported DIMM frequency of the processors

The system contains 24 memory sockets split into two sets of 12 sockets, one set per processor. Each 12-socket set is organized into four channels. In each channel, the release levers of the first socket are marked white, the second socket black, and the third socket green.

 **NOTE:** DIMMs in sockets A1 to A12 are assigned to processor 1 and DIMMs in sockets B1 to B12 are assigned to processor 2.

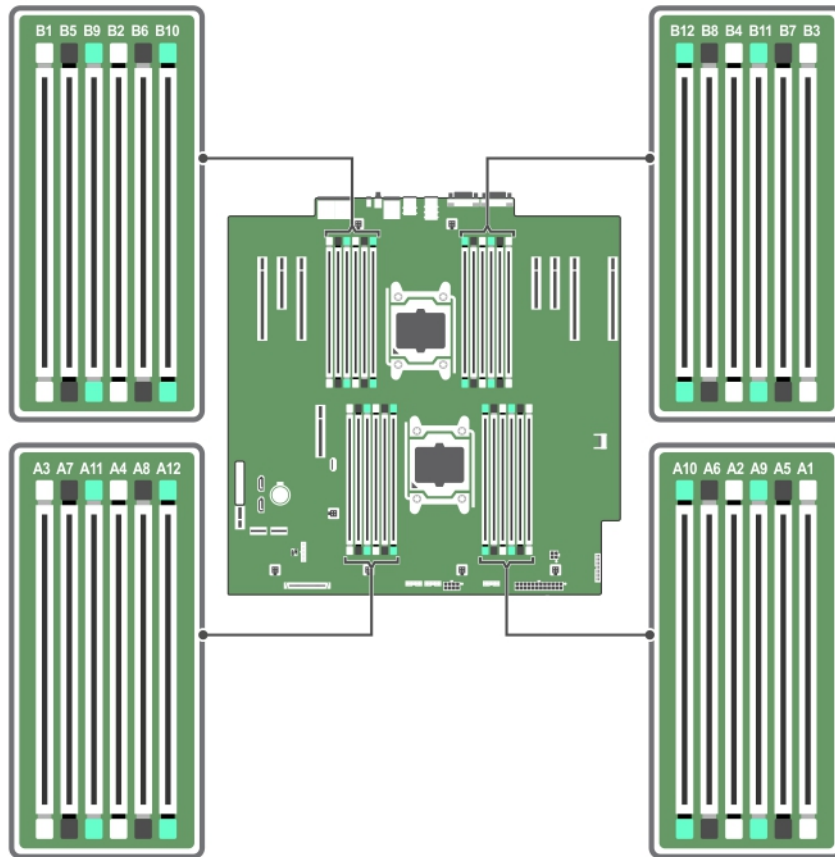

**Figure 16. Memory Socket Locations**

Memory channels are organized as follows:

- |                    |   |
|--------------------|---|
| <b>Processor 1</b> | channel 0: slots A1, A5, and A9<br>channel 1: slots A2, A6, and A10<br>channel 2: slots A3, A7, and A11<br>channel 3: slots A4, A8, and A12 |
| <b>Processor 2</b> | channel 0: slots B1, B5, and B9<br>channel 1: slots B2, B6, and B10<br>channel 2: slots B3, B7, and B11<br>channel 3: slots B4, B8, and B12 |

The following table shows the memory populations and operating frequencies for the supported configurations:



DIMM Type	DIMMs Populated/ Channel	Operating Frequency (in MT/s)	Maximum DIMM Rank/Channel
<b>1.2 V</b>			
RDIMM	1	2133, 1866, 1600, and 1333	Single rank or dual rank
	2	2133, 1866, 1600, and 1333	Single rank or dual rank
	3	1866, 1600, and 1333	Single rank or dual rank
LRDIMM	1	2133, 1866, 1600, and 1333	Quad rank
	2	2133, 1866, 1600, and 1333	Quad rank
	3	1866, 1600, and 1333	Quad rank

## General memory module installation guidelines

This system supports Flexible Memory Configuration, enabling the system to be configured and run in any valid chipset architectural configuration. The following are the recommended guidelines for installing memory modules:

- RDIMMs and LRDIMMs must not be mixed.
- x4 and x8 DRAM based DIMMs can be mixed. For more information, see [Mode-specific guidelines](#).
- Up to three dual- or single-rank RDIMMs can be populated per channel.
- Up to three LRDIMMs can be populated per channel regardless of rank count.
- Populate DIMM sockets only if a processor is installed. For single-processor systems, sockets A1 to A12 are available. For dual-processor systems, sockets A1 to A12 and sockets B1 to B12 are available.
- Populate all sockets with white release tabs first, then black, and then green.
- Populate the sockets by highest rank count in the following order — first in sockets with white release levers, then black, and then green. For example, if you want to mix single-rank and dual-rank DIMMs, populate dual-rank DIMMs in the sockets with white release tabs and single-rank DIMMs in the sockets with black release tabs.
- When mixing memory modules with different capacities, populate the sockets with memory modules with highest capacity first. For example, if you want to mix 4 GB and 8 GB DIMMs, populate 8 GB DIMMs in the sockets with white release tabs and 4 GB DIMMs in the sockets with black release tabs.
- In a dual-processor configuration, the memory configuration for each processor should be identical. For example, if you populate socket A1 for processor 1, then populate socket B1 for processor 2, and so on.
- Memory modules of different capacities can be mixed provided other memory population rules are followed (for example, 4 GB and 8 GB memory modules can be mixed).
- Mixing of more than two DIMM capacities in a system is not supported.
- Populate four DIMMs per processor (one DIMM per channel) at a time to maximize performance.

## Mode-specific guidelines

Four memory channels are allocated to each processor. The allowable configurations depend on the memory mode selected.

 **NOTE:** You can mix x4 and x8 DRAM based DIMMs to support RAS features. However, all guidelines for specific RAS features must be followed. x4 DRAM based DIMMs retain Single Device Data Correction (SDDC) in memory optimized (independent channel) mode. x8 DRAM based DIMMs require Advanced ECC mode to gain SDDC.

The following sections provide additional slot population guidelines for each mode:

## Advanced ECC (lockstep)

Advanced ECC mode extends SDDC from x4 DRAM based DIMMs to both x4 and x8 DRAMs. This protects against single DRAM chip failures during normal operation.

Memory installation guidelines:

- Memory modules must be identical in size, speed, and technology.
- DIMMs installed in memory sockets with white release tabs must be identical and similar rule applies for sockets with black and green release tabs. This ensures that identical DIMMs are installed in matched pairs - for example, A1 with A2, A3 with A4, A5 with A6, and so on.

 **NOTE:** Advanced ECC with Mirroring is not supported.

## Memory optimized (independent channel) mode

This mode supports SDDC only for memory modules that use x4 device width, and the mode does not impose any specific slot population requirements.

## Memory sparing

 **NOTE:** To use memory sparing, this feature must be enabled in the System Setup.

In this mode, one rank per channel is reserved as a spare. If persistent correctable errors are detected on a rank, the data from this rank is copied to the spare rank and the failed rank is disabled.

With memory sparing enabled, the system memory available to the operating system is reduced by one rank per channel. For example, in a dual-processor configuration with sixteen 4 GB dual-rank DIMMs, the available system memory is:  $\frac{3}{4}$  (ranks/channel)  $\times$  16 (DIMMs)  $\times$  4 GB = 48 GB, and not 16 (DIMMs)  $\times$  4 GB = 64 GB.

 **NOTE:** Memory sparing does not offer protection against a multi-bit uncorrectable error.

 **NOTE:** Both Advanced ECC/Lockstep and Optimizer modes support Memory Sparing.

## Memory mirroring

Memory Mirroring offers the strongest DIMM reliability mode compared to all other modes, providing improved uncorrectable multi-bit failure protection. In a mirrored configuration, the total available system memory is one half of the total installed physical memory. Half of the installed memory is used to mirror the active DIMMs. In the event of an uncorrectable error, the system switches over to the mirrored copy. This ensures SDDC and multi-bit protection.

Memory installation guidelines:

- Memory modules must be identical in size, speed, and technology.
- DIMMs installed in memory sockets with white release levers must be identical and similar rule applies for sockets with black and green release tabs. This ensures that identical DIMMs are installed in matched pairs - for example, A1 with A2, A3 with A4, A5 with A6, and so on.

## Sample memory configurations

The following tables show sample memory configurations for one and two processor configurations that follow the appropriate memory guidelines.

 **NOTE:** 1R, 2R, and 4R in the following tables indicate single-, dual-, and quad-rank DIMMs respectively.

**Table 1. Memory configurations—single processor**

System capacity (in GB)	DIMM size (in GB)	Number of DIMMs	DIMM rank, organization, and frequency	DIMM slot population
4	4	1	1R, x8, 2133 MT/s, 1R, x8, 1866 MT/s	A1
8	4	2	1R, x8, 2133 MT/s, 1R, x8, 1866 MT/s	A1, A2
16	4	4	1R, x8, 2133 MT/s, 1R, x8, 1866 MT/s	A1, A2, A3, A4
	8	2	2R, x8, 2133 MT/s, 2R, x8, 1866 MT/s	A1, A2
24	4	6	1R, x8, 2133 MT/s, 1R, x8, 1866 MT/s	A1, A2, A3, A4, A5, A6
	8	6	2R, x8, 2133 MT/s, 2R, x8, 1866 MT/s	A1, A2, A3, A4, A5, A6
48	4	12	1R, x8, 1866 MT/s, 1R, x8, 1600 MT/s	A1, A2, A3, A4, A5, A6, A7, A8, A9, A10, A11, A12
	8	6	2R, x8, 2133 MT/s, 2R, x8, 1866 MT/s	A1, A2, A3, A4, A5, A6
96	8	12	2R, x8, 1866 MT/s, 2R, x8 1600 MT/s	A1, A2, A3, A4, A5, A6, A7, A8, A9, A10, A11, A12
	16	6	2R, x4, 2133 MT/s, 2R, x4, 1866 MT/s	A1, A2, A3, A4, A5, A6
128	16	8	2R, x4, 2133 MT/s, 2R, x4, 1866 MT/s,	A1, A2, A3, A4, A5, A6, A7, A8
	16 and 8	10	2R, x4 and 2R, x8, 1866 MT/s  2R, x4 and 2R, x8, 1600 MT/s	A1, A2, A3, A4, A5, A6, A7, A8, A9, A11

System capacity (in GB)	DIMM size (in GB)	Number of DIMMs	DIMM rank, organization, and frequency	DIMM slot population
				 <b>NOTE:</b> 16 GB DIMMs must be installed in slots numbered A1, A2, A3, A4, A5, A6, A7, and A8 and 8 GB DIMMs must be installed in slots A9 and A11.
384	32	12	LRDIMM, x4, 1866 MT/s LRDIMM, x4, 1600 MT/s	A1, A2, A3, A4, A5, A6, A7, A8, A9, A10, A11, A12

**Table 2. Memory configurations—two processors**

System capacity (in GB)	DIMM size (in GB)	Number of DIMMs	DIMM rank, organization, and frequency	DIMM slot population
16	4	4	1R, x8, 2133 MT/s, 1R, x8, 1866 MT/s	A1, A2, B1, B2
32	4	8	1R, x8, 2133 MT/s, 1R, x8, 1866 MT/s	A1, A2, A3, A4, B1, B2, B3, B4
64	4	16	1R, x8, 2133 MT/s 1R, x8, 1866 MT/s	A1, A2, A3, A4, A5, A6, A7, A8, B1, B2, B3, B4, B5, B6, B7, B8
	8	8	2R, x8, 2133 MT/s, 2R, x8, 1866 MT/s	A1, A2, A3, A4, B1, B2, B3, B4
96	4	24	1R, x8, 1866 MT/s 1R, x8, 1600 MT/s	A1, A2, A3, A4, A5, A6, A7, A8, A9, A10, A11, A12, B1, B2, B3, B4, B5, B6, B7, B8, B9, B10, B11, B12
	8	12	2R, x8, 2133 MT/s, 2R, x8, 1866 MT/s	A1, A2, A3, A4, A5, A6, B1, B2, B3, B4, B5, B6
128	8	16	2R, x8, 2133 MT/s 2R, x8, 1866 MT/s	A1, A2, A3, A4, A5, A6, A7, A8, B1, B2, B3, B4, B5, B6, B7, B8
	16	8	2R, x4, 2133 MT/s, 2R, x4, 1866 MT/s	A1, A2, A3, A4, B1, B2, B3, B4

System capacity (in GB)	DIMM size (in GB)	Number of DIMMs	DIMM rank, organization, and frequency	DIMM slot population
160	8	20	2R, x8, 1866 MT/s	A1, A2, A3, A4, A5, A6, A7, A8, A9, A11, B1, B2, B3, B4, B5, B6, B7, B8, B9, B11
			2R, x8, 1600 MT/s	
	16 and 8	12	2R, x4, 2133 MT/s,	A1, A2, A3, A4, A5, A6, B1, B2, B3, B4, B5, B6
			2R, x8, 2133 MT/s, 2R, x4, 1866 MT/s 2R, x8, 1866 MT/s	 <b>NOTE:</b> 16 GB DIMMs must be installed in slots numbered A1, A2, A3, A4, B1, B2, B3, and B4 and 8 GB DIMMs must be installed in slots A5, A6, B5, and B6.
192	8	24	2R, x8, 1866 MT/s	A1, A2, A3, A4, A5, A6, A7, A8, A9, A10, A11, A12, B1, B2, B3, B4, B5, B6, B7, B8, B9, B10, B11, B12
			2R, x8, 1600 MT/s	
	16	12	2R, x4, 2133 MT/s,	A1, A2, A3, A4, A5, A6, B1, B2, B3, B4, B5, B6
			2R, x4, 1866 MT/s	
256	16	16	2R, x4, 2133 MT/s,	A1, A2, A3, A4, A5, A6, A7, A8, B1, B2, B3, B4, B5, B6, B7, B8
			2R, x4, 1866 MT/s,	
384	16	24	2R, x4, 1866 MT/s,	A1, A2, A3, A4, A5, A6, A7, A8, A9, A10, A11, A12, B1, B2, B3, B4, B5, B6, B7, B8, B9, B10, B11, B12
			2R, x4, 1600 MT/s,	
	32	12	LRDIMM, 4R, x4, 2133 MT/s	A1, A2, A3, A4, A5, A6, B1, B2, B3, B4, B5, B6
512	32	16	LRDIMM, 4R, x4, 2133 MT/s	A1, A2, A3, A4, A5, A6, A7, A8, B1, B2, B3, B4, B5, B6, B7, B8
768	32	24	LRDIMM, 4R, x4, 1866 MT/s	A1, A2, A3, A4, A5, A6, A7, A8, A9, A10, A11, A12, B1, B2, B3, B4, B5, B6, B7, B8, B9, B10, B11, B12
			LRDIMM, 4R, x4, 1600 MT/s	

## Removing memory modules

### Prerequisites

 **CAUTION:** Many repairs may only be done by a certified service technician. You should only perform troubleshooting and simple repairs as authorized in your product documentation, or as directed by the online or telephone service and support team. Damage due to servicing that is not authorized by Dell is not covered by your warranty. Read and follow the safety instructions that came with the product.

1. Ensure that you read the [Safety instructions](#).
2. Follow the procedure listed in [Before working inside your system](#).
3. Remove the cooling shroud.
4. If required, remove the cooling-fan assembly.

**⚠ WARNING: The memory modules are hot to the touch for some time after the system has been powered down. Allow time for the memory modules to cool before handling them. Handle the memory modules by the card edges and avoid touching the components or metallic contacts on the memory module.**

### Steps

1. Locate the appropriate memory module socket.

**⚠ CAUTION: Handle each memory module only by the card edges, making sure not to touch the middle of the memory module or gold contacts.**

2. To release the memory module from the socket, simultaneously press the ejectors on both ends of the memory-module socket.

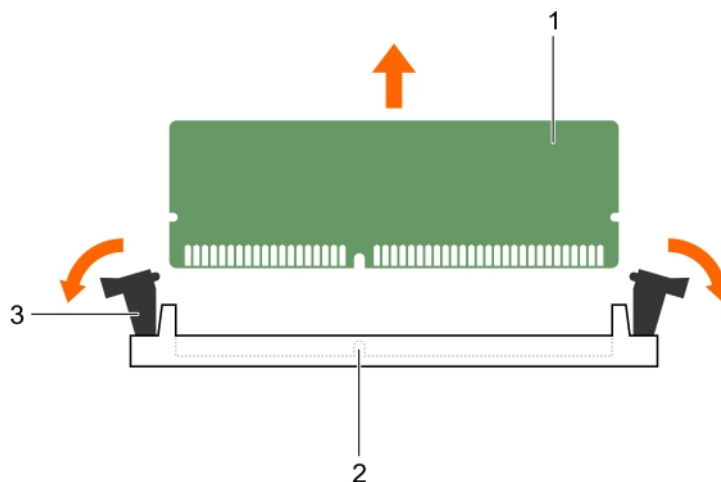

Figure 17. Removing and installing a memory module

- |                                     |                         |
|-------------------------------------|-------------------------|
| 1. memory-module                    | 2. memory-module socket |
| 3. memory module socket ejector (2) |                         |

## Installing memory modules

### Prerequisites

**⚠ CAUTION: Many repairs may only be done by a certified service technician. You should only perform troubleshooting and simple repairs as authorized in your product documentation, or as directed by the online or telephone service and support team. Damage due to servicing that is not authorized by Dell is not covered by your warranty. Read and follow the safety instructions that came with the product.**

1. Ensure that you read the [Safety instructions](#).

2. Follow the procedure listed in [Before working inside your system.](#)
3. Remove the cooling shroud.
4. Remove the cooling fan assembly.

**⚠ WARNING:** The memory modules are hot to the touch for some time after the system has been powered down. Allow time for the memory modules to cool before handling them. Handle the memory modules by the card edges and avoid touching the components or metallic contacts on the memory module.

#### Steps

1. Locate the appropriate memory-module socket.

**⚠ CAUTION:** Handle each memory module only by the card edges, making sure not to touch the middle of the memory module or gold contacts.

**⚠ CAUTION:** To prevent damage to the memory module or the memory-module socket during installation do not bend or flex the memory module; insert both ends of the memory module simultaneously.

2. Align the edge connector of the memory module with the alignment key of the memory module socket, and insert the memory module in the socket.

**📝 NOTE:** The alignment key allows you to install the memory module in the socket in only one way.

**⚠ CAUTION:** Do not apply pressure at the center of the memory module; apply pressure at both ends of the memory module evenly.

3. Press the memory module with your thumbs until the socket levers firmly click into place.

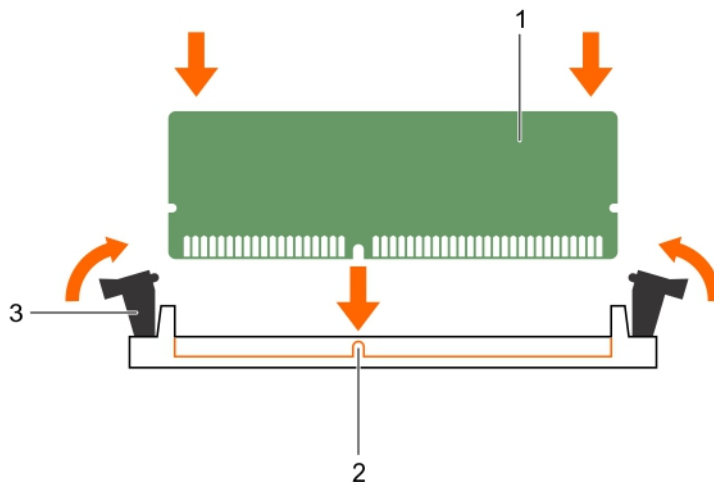

**Figure 18. Installing the memory module**

1. memory module
2. alignment key
3. memory-module socket ejector (2)

## Next steps

1. Install the cooling shroud.
2. Follow the procedure listed in [After working inside your system](#).
3. Press <F2> to enter **System Setup**, and check the **System Memory** setting.  
The system should have changed the value to reflect the installed memory.
4. If the value is incorrect, one or more of the memory modules may not be installed properly. Ensure that the memory modules are firmly seated in the sockets.
5. Run the system memory test in the system diagnostics.

## Flex bays

Your system's flex bay supports sixteen 2.5 inch hard drives or four Dell PowerEdge Express Flash devices.

### Removing a flex bay

#### Prerequisites

1. Ensure that you read the [Safety instructions](#).
2. Keep the #2 Phillips screwdriver ready.
3. Follow the procedure listed in [Before working inside your system](#).



**CAUTION: Many repairs may only be done by a certified service technician. You should only perform troubleshooting and simple repairs as authorized in your product documentation, or as directed by the online or telephone service and support team. Damage due to servicing that is not authorized by Dell is not covered by your warranty. Read and follow the safety instructions that came with the product.**

#### Steps

1. Remove the cables.
  - a. For a 2.5 inch drive flex bay, remove the cables from the slim optical-drive and the backplane.
  - b. For a Dell PowerEdge Express Flash device flex bay, remove the cables from the backplane.
2. Remove the two screws that secure the flex bay to the chassis.
3. Press the release latch and pull the flex bay from the chassis.



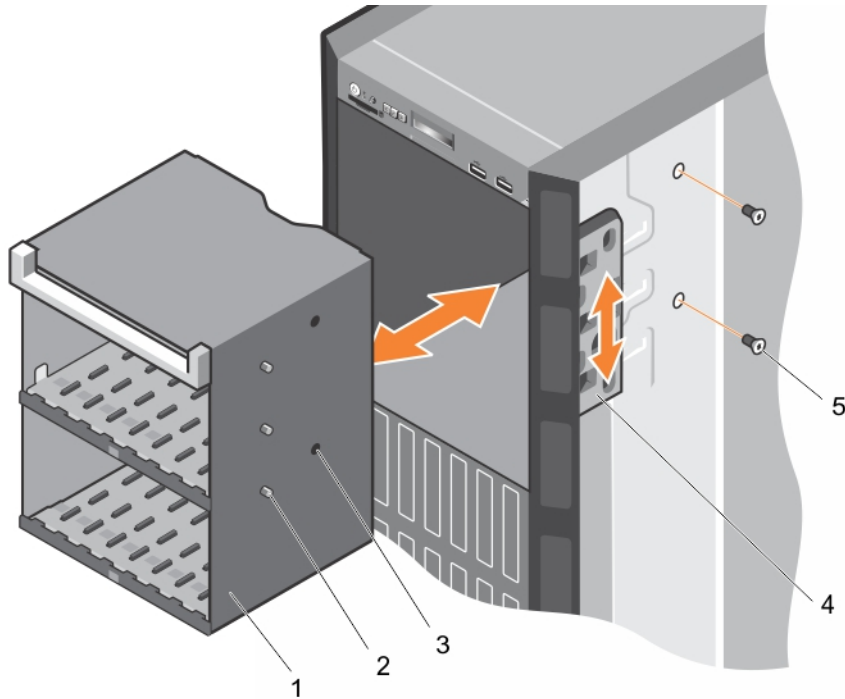

Figure 19. Removing and installing a flex bay

- |                   |                  |
|-------------------|------------------|
| 1. flex bay       | 2. tab (3)       |
| 3. screw hole (2) | 4. release latch |
| 5. screw (2)      |                  |

## Installing a flex bay

### Prerequisites

1. Ensure that you read the [Safety instructions](#).
2. Keep the #2 Phillips screwdriver ready.

**CAUTION:** Many repairs may only be done by a certified service technician. You should only perform troubleshooting and simple repairs as authorized in your product documentation, or as directed by the online or telephone service and support team. Damage due to servicing that is not authorized by Dell is not covered by your warranty. Read and follow the safety instructions that came with the product.

### Steps

1. Align the tabs on the flex bay with the slots on the front of the chassis.
2. Insert the flex bay into the chassis until the tabs click into place.
3. Install the two screws to secure the flex bay to the chassis.

### Next steps

Follow the procedure listed in [After working inside your system](#).

# Hard drives

Your system supports Enterprise-class hard drives, which are designed for 24x7 operating environment. Selecting the correct drive class will optimize quality, functionality, performance, and reliability of the hard drives.

Due to industry advances, in some cases, the larger capacity drives have been changed to a larger sector size. The larger sector size can have impacts on operating systems and applications. For more information about these hard drives, see the *512e and 4Kn Disk Formats* whitepaper and *4K Sector HDD FAQ* document at [dell.com/poweredgemanuals](http://dell.com/poweredgemanuals).

All hard drives are connected to the system board through the hard-drive backplane. Hard drives are supplied in hot-swappable hard-drive carriers that fit in the hard-drive slots.

 **CAUTION: Before attempting to remove or install a hard drive while the system is running, see the documentation for the storage controller card to ensure that the host adapter is configured correctly to support hot-swap hard drive removal and insertion.**

 **CAUTION: Do not turn off or reboot your system while the hard drive is being formatted. Doing so can cause a hard drive failure.**

Use only hard drives that have been tested and approved for use with the hard-drive backplane.

When you format a hard drive, allow enough time for the formatting to be completed. Be aware that high-capacity hard drives can take a number of hours to format.

## Removing a hot-swap hard drive

### Prerequisites

 **CAUTION: Many repairs may only be done by a certified service technician. You should only perform troubleshooting and simple repairs as authorized in your product documentation, or as directed by the online or telephone service and support team. Damage due to servicing that is not authorized by Dell is not covered by your warranty. Read and follow the safety instructions that came with the product.**

1. Ensure that you read the [Safety instructions](#).
2. If applicable, remove the bezel.
3. Using the management software, prepare the hard drive for removal. Wait until the indicators on the hard-drive carrier signal that the hard drive can be removed safely. For more information, see the documentation for the storage controller.

If the hard drive is online, the green activity/fault indicator flashes as the drive is turned off. When the hard-drive indicators are off, the hard drive is ready for removal.

 **CAUTION: To prevent data loss, ensure that your operating system supports hot-swap drive installation. See the documentation supplied with your operating system.**

### Steps

1. Press the release button to open the hard-drive carrier release handle.
2. Slide the hard-drive carrier out of the hard-drive slot.

 **CAUTION: To maintain proper system cooling, all empty hard-drive slots must have hard-drive blanks installed.**

3. If you are not replacing the hard drive immediately, insert a hard-drive blank in the empty hard-drive slot.

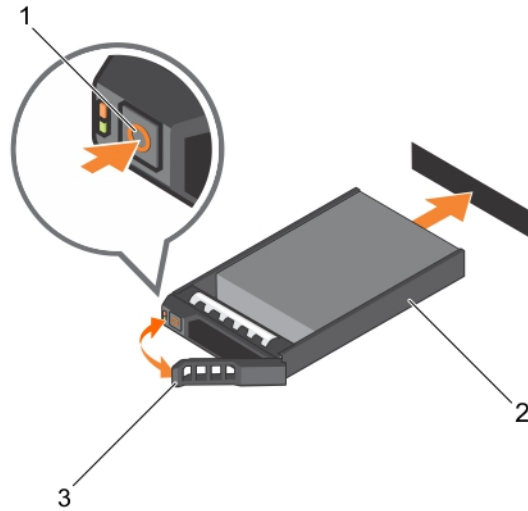

Figure 20. Removing and installing a hot-swap hard drive

1. release button
2. hard-drive carrier
3. hard-drive carrier handle

## Installing a hot-swap hard drive

### Prerequisites

- △ CAUTION: Many repairs may only be done by a certified service technician. You should only perform troubleshooting and simple repairs as authorized in your product documentation, or as directed by the online or telephone service and support team. Damage due to servicing that is not authorized by Dell is not covered by your warranty. Read and follow the safety instructions that came with the product.
- △ CAUTION: Use only hard drives that have been tested and approved for use with the hard-drive backplane.
- △ CAUTION: Combining SAS and SATA hard drives in the same RAID volume is not supported.
- △ CAUTION: When installing a hard drive, ensure that the adjacent drives are fully installed. Inserting a hard-drive carrier and attempting to lock its handle next to a partially installed carrier can damage the partially installed carrier's shield spring and make it unusable.
- △ CAUTION: To prevent data loss, ensure that your operating system supports hot-swap drive installation. See the documentation supplied with your operating system.
- △ CAUTION: When a replacement hot-swappable hard drive is installed and the system is powered on, the hard drive automatically begins to rebuild. Make absolutely sure that the replacement hard drive is blank or contains data that you wish to have over-written. Any data on the replacement hard drive is immediately lost after the hard drive is installed.

### Steps

1. If a hard-drive blank is installed in the hard-drive slot, remove it.
2. Install a hard drive in the hard-drive carrier.
3. Press the release button on the front of the hard-drive carrier and open the hard-drive carrier handle.
4. Insert the hard-drive carrier into the hard-drive slot until the carrier connects with the backplane.
5. Close the hard-drive carrier handle to lock the hard drive in place.

## Removing a 2.5 inch hard-drive blank

### Prerequisites

**△ CAUTION:** Many repairs may only be done by a certified service technician. You should only perform troubleshooting and simple repairs as authorized in your product documentation, or as directed by the online or telephone service and support team. Damage due to servicing that is not authorized by Dell is not covered by your warranty. Read and follow the safety instructions that came with the product.

**△ CAUTION:** To maintain proper system cooling, all empty hard-drive slots must have hard-drive blanks installed.

1. Ensure that you read the [Safety instructions](#).
2. If installed, remove the bezel.

### Steps

Press the release button and slide the hard-drive blank out of the hard-drive slot.

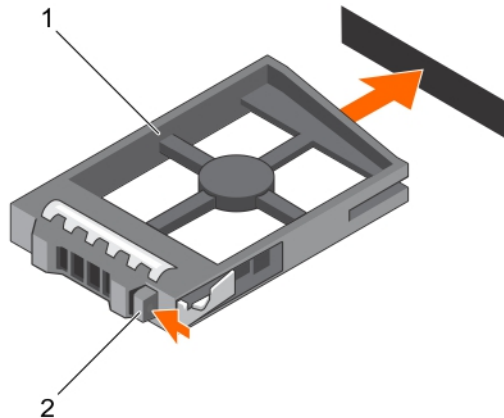

Figure 21. Removing and installing a 2.5 inch hard-drive blank

1. hard-drive blank
2. release button

## Installing a 2.5 inch hard-drive blank

### Prerequisites

1. Ensure that you read the [Safety instructions](#).

2. If installed, remove the front bezel.

### Steps

Insert the hard-drive blank into the hard-drive slot until the release button clicks into place.

### Next steps

If applicable, install the front bezel.

## Removing a 3.5 inch hard-drive blank

### Prerequisites

**⚠ CAUTION:** Many repairs may only be done by a certified service technician. You should only perform troubleshooting and simple repairs as authorized in your product documentation, or as directed by the online or telephone service and support team. Damage due to servicing that is not authorized by Dell is not covered by your warranty. Read and follow the safety instructions that came with the product.

**⚠ CAUTION:** To maintain proper system cooling, all empty hard-drive slots must have drive blanks installed.

1. Ensure that you read the [Safety instructions](#).
2. If installed, remove the front bezel.

### Steps

Press the release button and slide the blank out of the hard-drive slot.

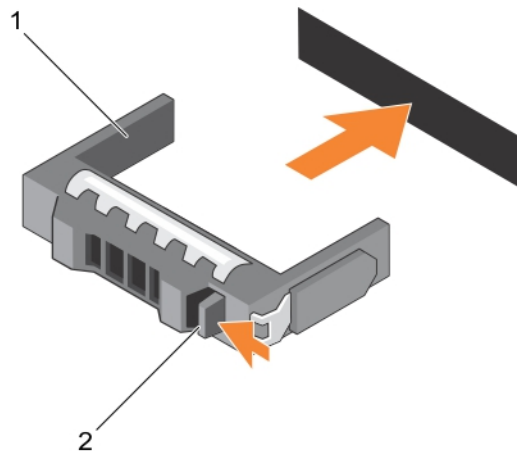

Figure 22. Removing and installing a 3.5 inch hard-drive blank

1. hard-drive blank
2. release button

### Next steps

If applicable, install the front bezel.

## Installing a 3.5 inch hard-drive blank

### Prerequisites

1. Ensure that you read the [Safety instructions](#).
2. If installed, remove the front bezel.

### Steps

Insert the hard-drive blank into the hard-drive slot until the release button clicks into place.

### Next steps

If applicable, install the front bezel.

## Installing a 2.5 inch hard drive into a 3.5 inch hard-drive adapter

### Prerequisites

**⚠ CAUTION:** Many repairs may only be done by a certified service technician. You should only perform troubleshooting and simple repairs as authorized in your product documentation, or as directed by the online or telephone service and support team. Damage due to servicing that is not authorized by Dell is not covered by your warranty. Read and follow the safety instructions that came with the product.

1. Keep the #2 Phillips screwdriver ready.
2. Ensure that you read the [Safety instructions](#).

### Steps

1. Align the screw holes on the 2.5 inch hard drive with the screw holes on the 3.5 inch hard-drive adapter.
2. Install the screws to secure the hard drive to the hard-drive adapter.

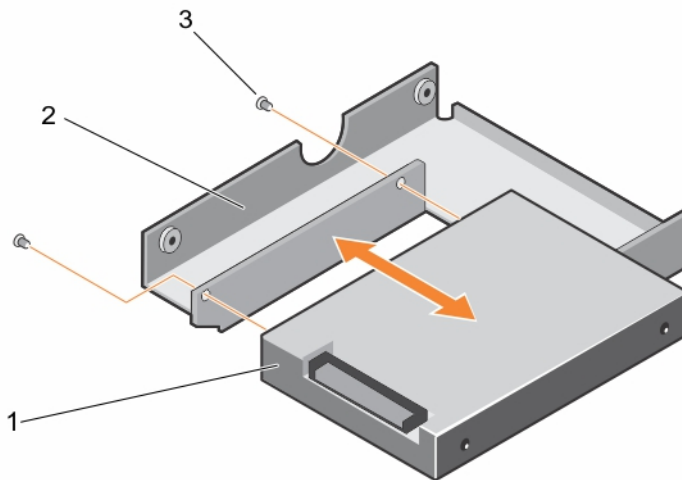

**Figure 23. Removing and Installing a 2.5 inch hard drive into a 3.5 inch hard-drive adapter**

1. 2.5 inch hard drive
2. 3.5 inch hard-drive adapter
3. screw (2)

## Removing a 2.5 inch hard drive from a 3.5 inch hard-drive adapter

### Prerequisites

 **CAUTION:** Many repairs may only be done by a certified service technician. You should only perform troubleshooting and simple repairs as authorized in your product documentation, or as directed by the online or telephone service and support team. Damage due to servicing that is not authorized by Dell is not covered by your warranty. Read and follow the safety instructions that came with the product.

1. Ensure that you read the [Safety instructions](#).
2. Keep the #2 Phillips screwdriver ready.

 **NOTE:** A 2.5 inch hard drive is installed in a 3.5 inch hard-drive adapter, which is then installed in the 3.5 inch hard-drive carrier.

### Steps

1. Remove the screws from the side of the 3.5 inch hard-drive adapter.
2. Remove the hard drive from the hard-drive adapter.

## Installing a hard-drive adapter into a hard-drive carrier

### Prerequisites

 **CAUTION:** Many repairs may only be done by a certified service technician. You should only perform troubleshooting and simple repairs as authorized in your product documentation, or as directed by the online or telephone service and support team. Damage due to servicing that is not authorized by Dell is not covered by your warranty. Read and follow the safety instructions that came with the product.

1. Ensure that you read the [Safety instructions](#).
2. Keep the #2 Phillips screwdriver ready.

### Steps

1. Insert the hard-drive adapter into the hard-drive carrier with the connector end of the hard drive toward the back of the hard-drive carrier.
2. Align the screw holes on the hard drive with the holes on the hard-drive carrier.
3. Install the screws to secure the hard drive to the hard-drive carrier.

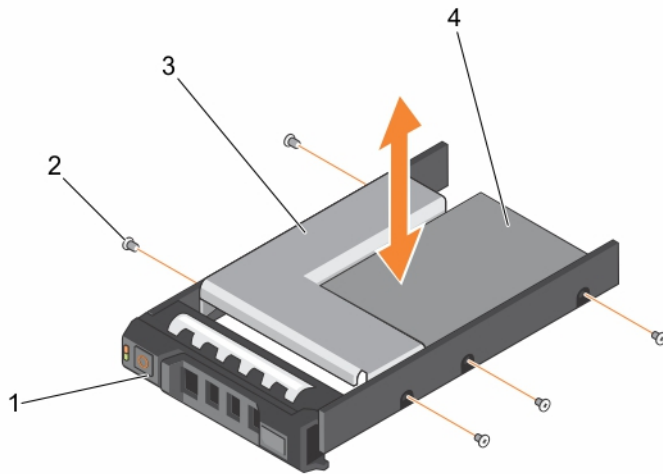

**Figure 24. Removing and installing a hard-drive adapter into a 3.5 inch hard-drive carrier**

- |                                |                        |
|--------------------------------|------------------------|
| 1. 3.5 inch hard-drive carrier | 2. screw (5)           |
| 3. hard-drive adapter          | 4. 2.5 inch hard drive |

## Removing a hard-drive adapter from a hard-drive carrier

### Prerequisites

1. Ensure that you read the [Safety instructions](#).
2. Keep the #2 Phillips screwdriver ready.

### Steps

1. Remove the screws from the slide rails on the hard-drive carrier.
2. Lift the hard-drive adapter out of the hard-drive carrier.

## Removing a hard drive from a hard-drive carrier

### Prerequisites

1. Keep the #1 Phillips screwdriver handy.
2. Remove the hard-drive carrier from the system.

### Steps

1. Remove the screws from the slide rails on the hard-drive carrier.
2. Lift the hard drive out of the hard-drive carrier.



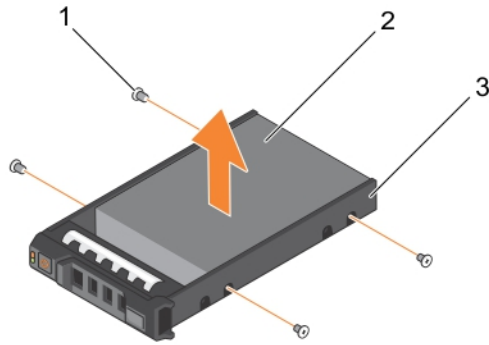

**Figure 25. Removing and installing a hard drive into a hard-drive carrier**

1. screw (4)
2. hard drive
3. hard-drive carrier

## Installing a hard drive into a hard-drive carrier

### Prerequisites

**⚠ CAUTION:** Many repairs may only be done by a certified service technician. You should only perform troubleshooting and simple repairs as authorized in your product documentation, or as directed by the online or telephone service and support team. Damage due to servicing that is not authorized by Dell is not covered by your warranty. Read and follow the safety instructions that came with the product.

Keep the #1 Phillips screwdriver handy.

### Steps

1. Insert the hard drive into the hard-drive carrier with the connector end of the hard drive toward the back.
2. Align the screw holes on the hard drive with the set of screw holes on the hard-drive carrier. When aligned correctly, the back of the hard drive is flush with the back of the hard-drive carrier.
3. Attach the screws to secure the hard drive to the hard-drive carrier.

## Optical drives and tape drives

Your system supports one of the following configurations:

System	Configurations
Systems with up to eight 3.5 inch hard drives or sixteen 2.5 inch hard drives	Up to three SATA half height optical drives
	Up to three SATA/SAS/SCSI tape drives
	A combination of optical and tape drives

System	Configurations
Systems with up to eight 3.5 inch hard drives or eight 2.5 inch hard drives in the 3.5 inch hard-drive carrier, or sixteen 2.5 inch hard drives plus four PCIe SSDs	Up to one SATA half height optical drive Up to one SATA/SAS/SCSI tape drive
Systems with up to eighteen 3.5 inch hard drives	One optical or tape drive
Systems with up to thirty-two 2.5 inch hard drives	One slim optical drive with option to choose from DVD-ROM or DVD-RW. Tape drives are not supported.

## Removing the optical drive or tape drive



### Prerequisites

1. Ensure that you read the [Safety instructions](#).
2. Follow the procedure listed in [Before working inside your system](#).



**CAUTION:** Many repairs may only be done by a certified service technician. You should only perform troubleshooting and simple repairs as authorized in your product documentation, or as directed by the online or telephone service and support team. Damage due to servicing that is not authorized by Dell is not covered by your warranty. Read and follow the safety instructions that came with the product.

### Steps

1. Disconnect the power and data cable from the back of the drive.
  -  **NOTE:** Observe the routing of the power and data cable inside the chassis as you remove them from the system board and the drive. You must route these cables properly when you replace them to prevent them from being pinched or crimped.
2. To remove the drive, push the release latch as indicated in the figure.
3. Slide the drive out of the drive bay.
4. If you are not immediately replacing the optical drive or tape drive, install the blank.
  -  **NOTE:** Blanks must be installed on empty optical drive or tape drive slots to maintain FCC certification of the system. The brackets also keep dust and dirt out of the system and aid in proper cooling and airflow inside the system. Perform the same steps to install blanks.

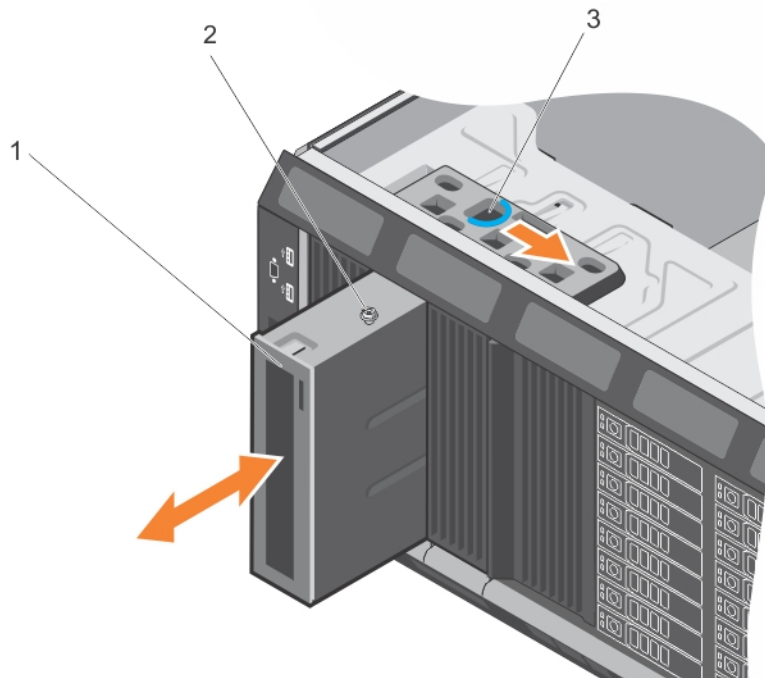

**Figure 26. Removing and installing the optical drive or tape drive**

1. optical drive/tape drive
2. guide
3. release latch

 **NOTE:** The following figure shows the cabling diagram for an optical drive/tape drive with an x16 backplane. All backplanes (x8, x18, and x16) have an ODD connector.

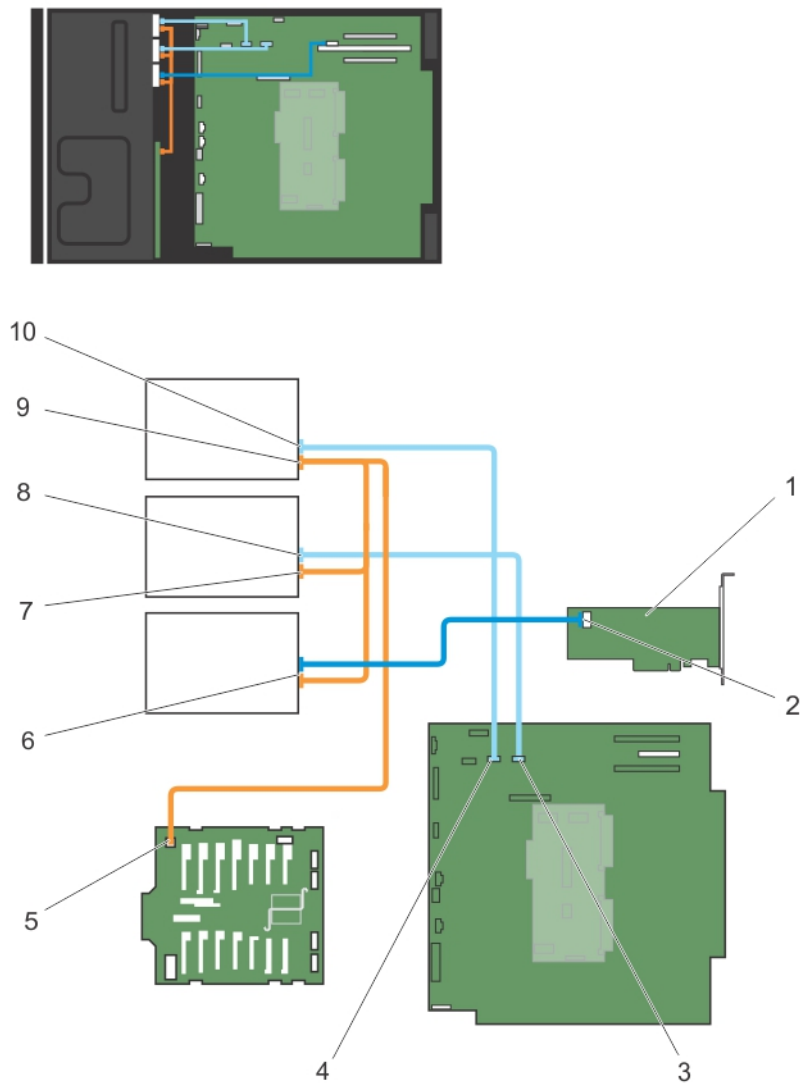

**Figure 27. Cabling— optical drive and tape drive**

- |                                       |   |
|---------------------------------------|---|
| 1. internal tape adapter              | 2. mini-SAS/SATA connector on internal tape adapter |
| 3. ODD2/TBU connector on system board | 4. ODD1/TBU connector on system board               |
| 5. power connector on x16 backplane   | 6. SAS tape drive data/power connector              |
| 7. optical drive 2 power connector    | 8. optical drive 2 data connector                   |
| 9. optical drive 1 power connector    | 10. optical drive 1 data connector                  |

### Next steps

Follow the procedure listed in [After working inside your system.](#)

## Installing the optical drive or tape drive

### Prerequisites

 **CAUTION:** Many repairs may only be done by a certified service technician. You should only perform troubleshooting and simple repairs as authorized in your product documentation, or as directed by the online or telephone service and support team. Damage due to servicing that is not authorized by Dell is not covered by your warranty. Read and follow the safety instructions that came with the product.

1. Ensure that you read the [Safety instructions](#).
2. Follow the procedure listed in [Before working inside your system](#).

### Steps

1. Unpack and prepare the drive for installation.  
For instructions, see the documentation that accompanied the drive.

If you are installing a SAS tape drive, you must have an internal tape adapter installed. For more information on installing a SAS tape drive, see [Installing an expansion card](#).

2. If applicable, remove the old drive or the drive blank.
3. Align the guide on the drive with the slot on drive bay.
4. Slide the drive into the slot until the latch snaps into place.
5. Connect the power and data cable to the back of the drive.
6. Connect the power and data cables to the backplane and the system board.

The system board connectors are ODD1/TBU and ODD2/TBU. The system can connect up to two optical drives, or one optical drive with one SATA tape backup unit, and one SAS tape backup unit using Dell OpenManage IT Assistant.

 **NOTE:** For systems configured with software RAID and installed with PowerVault RD1000, connect the PowerVault RD1000 data cable to ODD1/TBU (SATA\_E) port and the optical drive data cable to ODD2/TBU (SATA\_F) port on the system board respectively.

### Next steps

Follow the procedure listed in [After working inside your system](#).

## Removing the slim optical drive blank

Follow the same procedure to remove the slim optical drive.

### Prerequisites

1. Ensure that you read the [Safety instructions](#).
2. Follow the procedure listed in [Before working inside your system](#).

 **CAUTION:** Many repairs may only be done by a certified service technician. You should only perform troubleshooting and simple repairs as authorized in your product documentation, or as directed by the online or telephone service and support team. Damage due to servicing that is not authorized by Dell is not covered by your warranty. Read and follow the safety instructions that came with the product.

### Steps

1. Locate the touch point for the slim optical drive blank lock inside the system.
2. Press the lock and pull the slim optical drive blank out of the chassis.

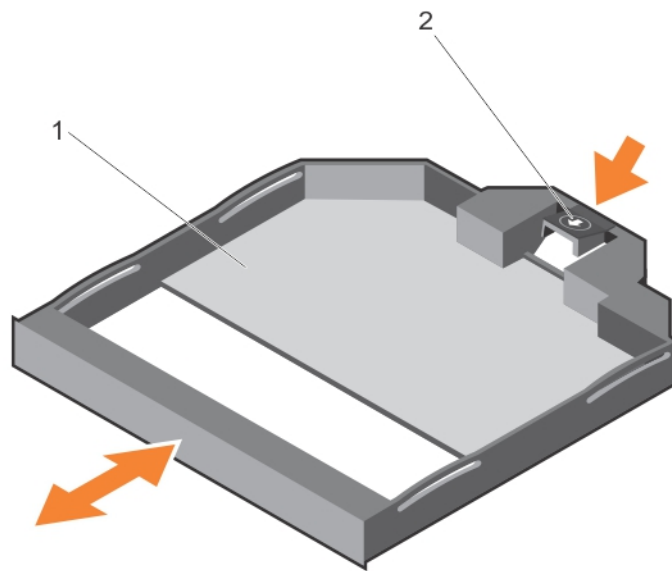

**Figure 28. Removing and installing the slim optical drive blank**

1. slim optical drive blank
2. optical drive blank lock

## Installing the slim optical drive blank

### Prerequisites

Ensure that you read the [Safety instructions](#).

**CAUTION:** Many repairs may only be done by a certified service technician. You should only perform troubleshooting and simple repairs as authorized in your product documentation, or as directed by the online or telephone service and support team. Damage due to servicing that is not authorized by Dell is not covered by your warranty. Read and follow the safety instructions that came with the product.

### Steps

1. Align the slim optical drive blank with the slim optical drive bay.
2. Slide the optical drive blank into the optical drive bay until the lock clicks into place.

### Next steps

Follow the procedure listed in [After working inside your system](#).

## Internal USB memory key (optional)

An optional USB memory key installed inside your system can be used as a boot device, security key, or mass storage device. The USB connector must be enabled by the **Internal USB Port** option in the **Integrated Devices** screen of the System Setup.

To boot from the USB memory key, configure the USB memory key with a boot image and then specify the USB memory key in the boot sequence in the System Setup.

 **NOTE:** To locate the internal USB connector (INT\_USB) on the system board, see [System board connectors](#).

## Replacing the internal USB key

### Prerequisites

1. Ensure that you read the [Safety instructions](#).
2. Follow the procedure listed in [Before working inside your system](#).

 **CAUTION:** Many repairs may only be done by a certified service technician. You should only perform troubleshooting and simple repairs as authorized in your product documentation, or as directed by the online or telephone service and support team. Damage due to servicing that is not authorized by Dell is not covered by your warranty. Read and follow the safety instructions that came with the product.

### Steps

1. Locate the USB connector or USB key on the system board.

 **NOTE:** To locate the internal USB connector on the system board, see [System board connectors](#).

2. If installed, remove the USB key.
3. Insert the new USB key into the USB connector.

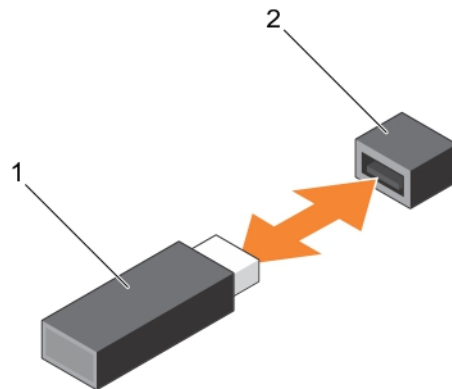

**Figure 29. Replacing the internal USB key**

1. USB memory key
2. USB memory key connector

### Next steps

1. Follow the procedure listed in [After working inside your system](#).
2. While booting, press <F2> to enter the System Setup and verify that the USB key is detected by the system.

# Expansion card holder

## Removing the expansion card holder

### Prerequisites

1. Ensure that you read the [Safety instructions](#).
2. Follow the procedure listed in [Before working inside your system](#).

**△ CAUTION:** Many repairs may only be done by a certified service technician. You should only perform troubleshooting and simple repairs as authorized in your product documentation, or as directed by the online or telephone service and support team. Damage due to servicing that is not authorized by Dell is not covered by your warranty. Read and follow the safety instructions that came with the product.

### Steps

Press the tab and pull the expansion card holder from the chassis.

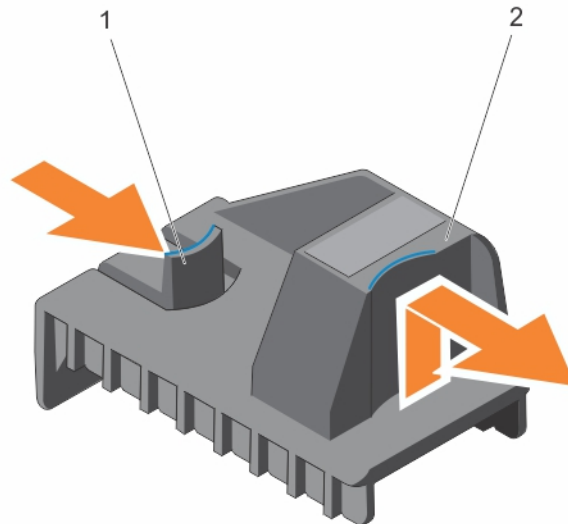

Figure 30. Removing and installing the expansion card holder

1. tab
2. expansion card holder

## Installing the expansion card holder

### Prerequisites

**△ CAUTION:** Many repairs may only be done by a certified service technician. You should only perform troubleshooting and simple repairs as authorized in your product documentation, or as directed by the online or telephone service and support team. Damage due to servicing that is not authorized by Dell is not covered by your warranty. Read and follow the safety instructions that came with the product.

Ensure that you read the [Safety instructions](#).



## Steps

Align the expansion card holder with the projections on the chassis and push it down until firmly seated.

## Next steps

Follow the procedure listed in [After working inside your system](#).

# Expansion cards

## Expansion card installation guidelines

The following table describes the supported expansion cards:

**Table 3. Supported PCI express generation 3 expansion cards**

PCIe Slot	Processor Connection	Height	Length	Link Width	Slot Width
1	Processor 1	Standard Height	Full Length	x16	x16
2	Platform Controller Hub	Standard Height	Full Length*	x4	x8
3	Processor 1	Standard Height	Full Length	x16	x16
4	Processor 2	Standard Height	Half Length	x8	x8
5	Processor 2	Standard Height	Full Length*	x4	x8
6	Processor 2	Standard Height	Full Length	x16	x16
7	Processor 2	Standard Height	Full Length	x16	x16
8	Processor 1	Standard Height	Half Length	x8	x8

\*PCIe Generation 2 expansion card.

 **NOTE:** To use PCIe slots 4, 5, 6, and 7, both the processors must be installed.

 **NOTE:** The expansion-card slots are not hot-swappable.

The following table describes the installation order for installing expansion cards to ensure proper cooling and mechanical fit. The expansion cards with the highest priority must be installed first using the slot priority indicated. All other expansion cards must be installed in card priority and slot priority order.

**Table 4. Expansion card installation order**

CPU	Card Priority	Card Type	Slot Priority	Maximum Allowed
CPU1	1	Dell PowerEdge Express Flash (PCIe SSD) Bridge	1, 3	1
	2	GPU (single width and double width)	3, 1	2
	3	RAID	8, 1, 3	2
	4	40 Gb NICs	3, 1	2

CPU	Card Priority	Card Type	Slot Priority	Maximum Allowed
	5	FC16 HBA	3, 1	2
	6	10 Gb NICs	3, 1, 2	3
	7	FC8 HBA	3, 1, 2	3
	8	FC4 HBA	3, 1, 2	3
	9	1 Gb NICs	3, 1, 2	3
	10	Non-RAID	3, 1	2
	1	Dell PowerEdge Express Flash (PCIe SSD) Bridge	1, 3	1
	2	GPU (single width and double width)	3, 6, 7, 1	4
	3	RAID	8, 1, 3, 4, 6, 7	5
	4	40 Gb NICs	3, 4, 6, 7, 1	5
CPU2	5	FC16 HBA	3, 4, 6, 7, 1	5
	6	10 Gb NICs	3, 4, 6, 7, 1, 5, 2	7
	7	FC8 HBA	3, 4, 6, 7, 1, 5, 2	7
	8	FC4 HBA	3, 4, 6, 7, 1, 5, 2	7
	9	1 Gb NICs	3, 4, 6, 7, 1, 5, 2	7
	10	Non-RAID	3, 4, 6, 7, 1	5

## Removing an expansion card

### Prerequisites

1. Ensure that you read the [Safety instructions](#).
2. Follow the procedure listed in [Before working inside your system](#).
3. Remove the expansion card holder.



**CAUTION: Many repairs may only be done by a certified service technician. You should only perform troubleshooting and simple repairs as authorized in your product documentation, or as directed by the online or telephone service and support team. Damage due to servicing that is not authorized by Dell is not covered by your warranty. Read and follow the safety instructions that came with the product.**

### Steps

1. If installed, disconnect the data cables from the PERC card and/or the power cables from the GPU card.
2. Press the expansion card latch and push the latch towards the back to open it.
3. Hold the expansion card by its edge, pull the card up to remove it from the expansion card connector and the system.
4. Install the filler brackets by performing the following steps:
  - a. Align the slot on the filler bracket with the tab on the expansion card slot.

- b. Press the expansion card latch till the filler bracket locks into place.

 **NOTE:** Filler brackets must be installed in empty expansion-card slots to maintain FCC certification of the system. The brackets also keep dust and dirt out of the system and aid in proper cooling and airflow inside the system.

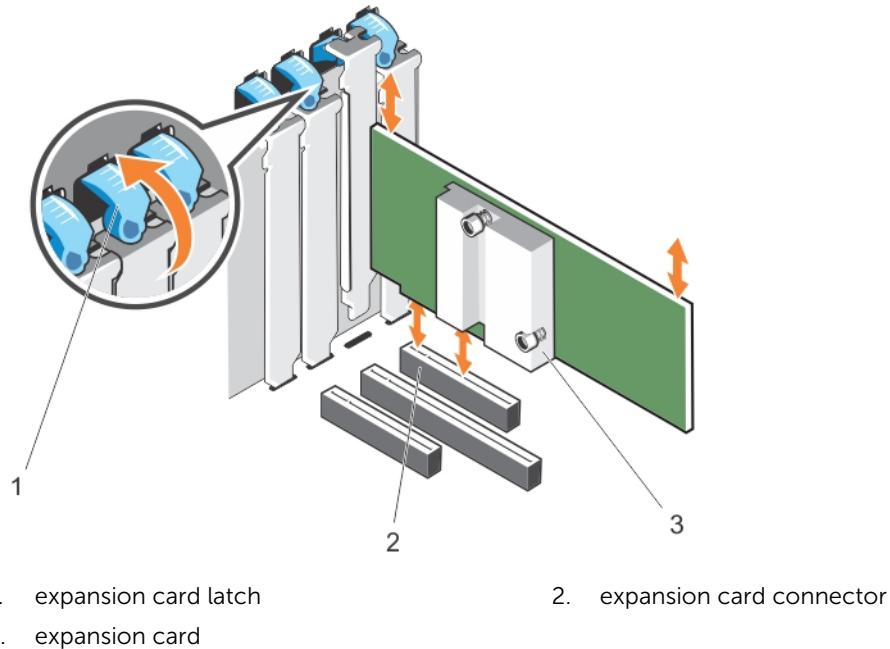

## Installing an expansion card

### Prerequisites

1. Ensure that you read the [Safety instructions](#).
2. Follow the procedure listed in [Before working inside your system](#).
3. Remove the expansion card holder.

 **CAUTION:** Many repairs may only be done by a certified service technician. You should only perform troubleshooting and simple repairs as authorized in your product documentation, or as directed by the online or telephone service and support team. Damage due to servicing that is not authorized by Dell is not covered by your warranty. Read and follow the safety instructions that came with the product.

### Steps

1. Unpack the expansion card and prepare it for installation.  
For instructions, see the documentation accompanying the card.
2. Open the expansion card latch adjacent to the slot you want to install the expansion card.
3. If you are installing a new card, remove the filler bracket.

 **NOTE:** Keep this bracket in case you need to remove the expansion card. Filler brackets must be installed in empty expansion-card slots to maintain FCC certification of the system. The brackets also keep dust and dirt out of the system and aid in proper cooling and airflow inside the system.

4. Holding the card by its edges, position the card so that the card-edge connector aligns with the expansion card connector.
5. Insert the card-edge connector firmly into the expansion card connector until the card is fully seated.
6. Close the expansion card latch by pushing the latch up until the latch snaps into place.
7. Connect any cables to the expansion card.
8. Replace the expansion card holder.

#### Next steps

1. Install the expansion card holder.
2. Follow the procedure listed in [After working inside your system](#).

## GPU card holder (optional)

### Removing the GPU card holder

#### Prerequisites

1. Ensure that you read the [Safety instructions](#).
2. Follow the procedure listed in [Before working inside your system](#).
3. Remove the cooling shroud.



**CAUTION: Many repairs may only be done by a certified service technician. You should only perform troubleshooting and simple repairs as authorized in your product documentation, or as directed by the online or telephone service and support team. Damage due to servicing that is not authorized by Dell is not covered by your warranty. Read and follow the safety instructions that came with the product.**

#### Steps

Press the release tab and pull the GPU card holder out from the chassis.

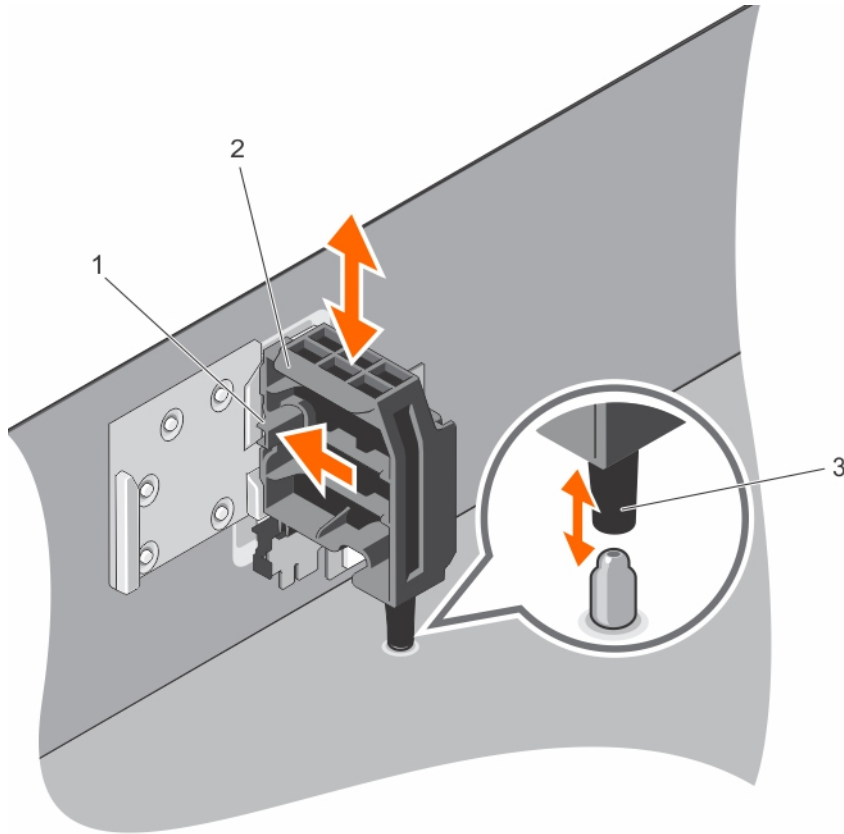

Figure 31. Removing and installing the GPU card holder

- |                |                    |
|----------------|--------------------|
| 1. release tab | 2. GPU card holder |
| 3. guide pin   |                    |

#### Next steps

1. Install the cooling shroud.
2. Follow the procedure listed in [After working inside your system](#).

### Installing the GPU card holder

#### Prerequisites

1. Ensure that you read the [Safety instructions](#).
2. Follow the procedure listed in [Before working inside your system](#).

**⚠ CAUTION:** Many repairs may only be done by a certified service technician. You should only perform troubleshooting and simple repairs as authorized in your product documentation, or as directed by the online or telephone service and support team. Damage due to servicing that is not authorized by Dell is not covered by your warranty. Read and follow the safety instructions that came with the product.

## Steps

Align the GPU card holder with the slots on the chassis and the guide pin, and push till it is firmly seated.

## Next steps

Follow the procedure listed in [After working inside your system](#).

# GPU cards (optional)

## GPU card installation guidelines

Observe the following guidelines while installing a GPU card:

- Ensure that the GPU enablement kit is ready.
- Ensure that all GPU cards are of the same type or model.
- Each GPU card supports up to 6 GB of dedicated GDDR5 memory.
- A single processor configuration only supports up to two double or single width cards on slots 1 and 3.
- A dual processor configuration supports up to four double or single width cards on slots 1, 3, 6, and 7.
- Both the processors must be installed to use slots 6 and 7.
- Two double-width GPU cards on a single processor configuration and four double width GPU cards on a dual processor configuration do not support any other add-on cards.
- On a system with four double-width GPU cards, the hard-drive setting must be either onboard SATA controller or S110.
- Four double-width 300 W GPU cards (Intel 3120A or Intel 7120A) on a dual processor configuration or two double-width 300 W GPU cards (Intel 3120A or Intel 7120A) on a single processor configuration cannot operate at an ambient temperature above 30 °C.
- The 3.5 inch x18 hard-drive system configuration supports two double-width 300 W GPU cards (Intel 3120A or Intel 7120A) on slots 3 and 6 on dual processor configuration, and one double-width 300 W GPU card (Intel 3120A or Intel 7120A) on slot 3 on single processor configuration.
- Two single-width GPU cards on a single processor configuration and four single-width GPU cards on a dual processor configuration do not support H730, H730P, and H830 PERC cards.
- A system with Express Flash configuration supports a maximum of two GPU cards.
- The GPU cards must be installed:
  - On the x16 PCIe Generation 3 interfaces available on slots 1, 3, 6, and 7.
  - On systems that support one 5.25-inch removable media storage devices.
  - On systems with six fan configuration.
  - On systems that have 1100 W and 1600 W power supply.

 **NOTE:** When you have more than two GPU cards on your system, you will need two 1100 W PSUs installed on your system.

## Removing a GPU card

### Prerequisites

1. Ensure that you read the [Safety instructions](#).
2. Follow the procedure listed in [Before working inside your system](#).
3. Remove the cooling shroud.

4. Remove the expansion card holder.

**CAUTION:** Many repairs may only be done by a certified service technician. You should only perform troubleshooting and simple repairs as authorized in your product documentation, or as directed by the online or telephone service and support team. Damage due to servicing that is not authorized by Dell is not covered by your warranty. Read and follow the safety instructions that came with the product.

### Steps

1. Disconnect the cables from the GPU card.

**CAUTION:** Do not use excessive force when removing the cables as it can damage the connectors.

2. Open the two expansion card latches by pressing the latch and then pushing the latch toward the rear.
3. Hold the card by its edge, pull the card up to remove it from the card connector and the system.

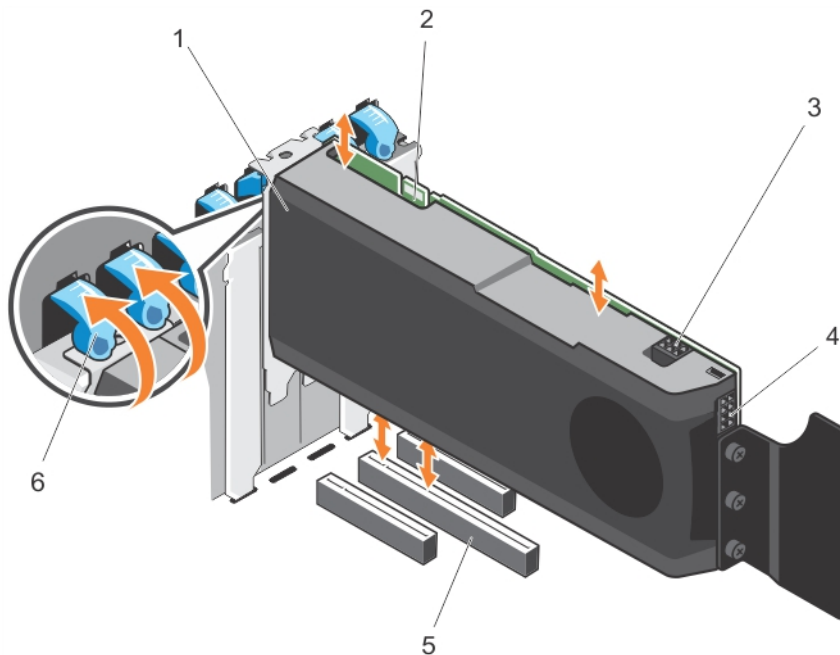

**Figure 32. Removing and installing a GPU card**

- |                             |                             |
|-----------------------------|-----------------------------|
| 1. GPU card                 | 2. SLI data connector       |
| 3. GPU card power connector | 4. GPU card power connector |
| 5. x16 connector            | 6. expansion card latch (2) |

### Next steps

1. Install the filler brackets by performing the following steps:
  - a. Align the slot on the filler bracket with the tab on the expansion card slot.
  - b. Press the expansion card latch till the filler bracket locks into place.

**NOTE:** Filler brackets must be installed in empty expansion-card slots to maintain FCC certification of the system. The brackets also keep dust and dirt out of the system and aid in proper cooling and airflow inside the system.

2. Close the two expansion card latches by pushing the latch until the latch snaps into place.
3. Replace the expansion card holder.
4. Install the cooling shroud.
5. Follow the procedure listed in [After working inside your system](#).

## Installing a GPU card

### Prerequisites

 **CAUTION:** Many repairs may only be done by a certified service technician. You should only perform troubleshooting and simple repairs as authorized in your product documentation, or as directed by the online or telephone service and support team. Damage due to servicing that is not authorized by Dell is not covered by your warranty. Read and follow the safety instructions that came with the product.

1. Ensure that you read the [Safety instructions](#).
2. Follow the procedure listed in [Before working inside your system](#).
3. Remove the cooling shroud. For more information, see [Removing the cooling shroud](#).
4. Remove the expansion card holder. For more information, see [Removing the expansion card holder](#).
5. Open the two expansion card latches.
6. Remove the filler brackets. For more information, see [Removing a GPU card](#)

 **NOTE:** Keep this bracket in case you need to remove the expansion card. Filler brackets must be installed in empty expansion-card slots to maintain FCC certification of the system. The brackets also keep dust and dirt out of the system and aid in proper cooling and airflow inside the system.

### Steps

1. Locate the x16 slot on the system board.
2. Insert the GPU card into the slot.
3. Connect the cables to the GPU card.
4. Close the two expansion card latches.

### Next steps

1. Install the expansion card holder.
2. Install the cooling shroud.
3. Follow the procedure listed in [After working inside your system](#).

## Internal dual SD module

 **NOTE:** When the **Redundancy** option is set to **Mirror Mode** in the **Integrated Devices** screen of the System Setup, the information is replicated from one SD card to another.

## Removing the internal dual SD module

### Prerequisites

1. Ensure that you read the [Safety instructions](#).
2. Follow the procedure listed in [Before working inside your system](#).



**CAUTION:** Many repairs may only be done by a certified service technician. You should only perform troubleshooting and simple repairs as authorized in your product documentation, or as directed by the online or telephone service and support team. Damage due to servicing that is not authorized by Dell is not covered by your warranty. Read and follow the safety instructions that came with the product.

**Steps**

1. Locate the internal dual SD module the system board.
2. If installed, remove the SD card(s).
3. Hold the plastic pull tab and pull the dual SD module out of the system board.

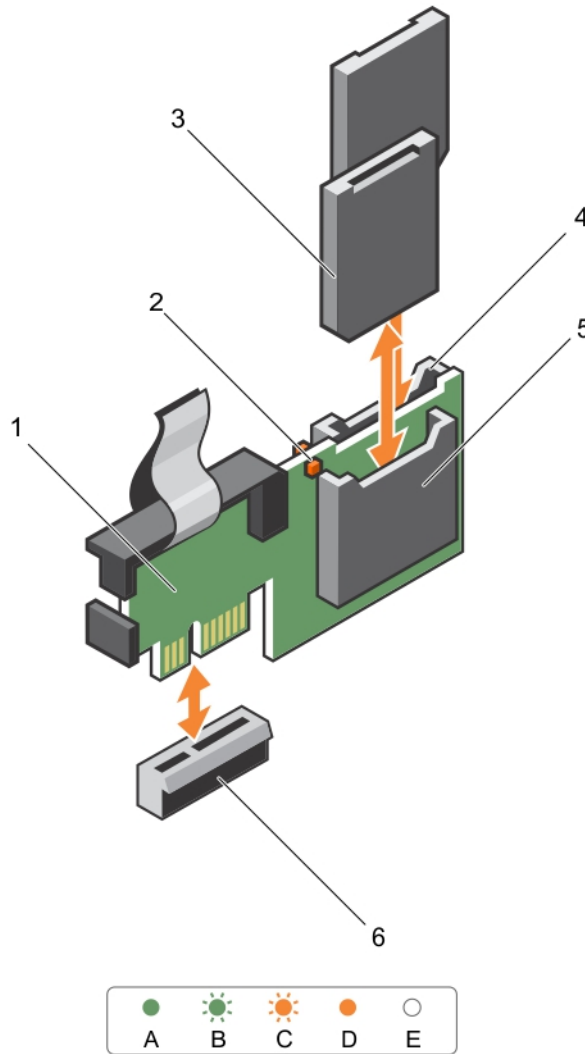

**Figure 33. Removing and installing the Internal Dual SD Module (IDSDM)**

1. Internal Dual SD module
2. LED status indicator (2)

- 3. SD card (2)
- 4. SD card slot 2
- 5. SD card slot 1
- 6. IDSDM connector

The following table describes the IDSDM indicator codes.

Convention	IDSDM indicator code	Condition
A	Green	Indicates that the card is online
B	Flashing green	Indicates rebuild or activity
C	Flashing amber	Indicates card mismatch or that the card has failed
D	Amber	Indicates that the card is offline, has failed, or is write protected
E	Not lit	Indicates that the card is missing or is booting

#### Next steps

Follow the procedure listed in [After working inside your system](#).

## Installing the internal dual SD module

#### Prerequisites

1. Ensure that you read the [Safety instructions](#).
2. Follow the procedure listed in [Before working inside your system](#).

 **CAUTION:** Many repairs may only be done by a certified service technician. You should only perform troubleshooting and simple repairs as authorized in your product documentation, or as directed by the online or telephone service and support team. Damage due to servicing that is not authorized by Dell is not covered by your warranty. Read and follow the safety instructions that came with the product.

#### Steps

1. Locate the IDSDM connector on the system board.
2. Align the connectors on the system board and the dual SD module.
3. Push the dual SD module until it is firmly seated on the system board.

#### Next steps

1. Install the SD vFlash media card(s).
2. Follow the procedure listed in [After working inside your system](#).

## Internal SD card

### Removing an internal SD card

#### Prerequisites

1. Ensure that you read the [Safety instructions](#).
2. Follow the procedure listed in [Before working inside your system](#).

 **CAUTION:** Many repairs may only be done by a certified service technician. You should only perform troubleshooting and simple repairs as authorized in your product documentation, or as directed by the online or telephone service and support team. Damage due to servicing that is not authorized by Dell is not covered by your warranty. Read and follow the safety instructions that came with the product.

#### Steps

Locate the SD card slot on the internal dual SD module and press the card to release it from the slot.

#### Next steps

Follow the procedure listed in [After working inside your system](#).

## Installing an internal SD card

#### Prerequisites

1. Ensure that you read the [Safety instructions](#).
2. Follow the procedure listed in [Before working inside your system](#).
3. If installed, remove the cooling shroud.

 **CAUTION:** Many repairs may only be done by a certified service technician. You should only perform troubleshooting and simple repairs as authorized in your product documentation, or as directed by the online or telephone service and support team. Damage due to servicing that is not authorized by Dell is not covered by your warranty. Read and follow the safety instructions that came with the product.

 **NOTE:** To use an SD card with your system, ensure that the **Internal SD Card Port** is enabled in the System Setup.

#### Steps

1. Locate the SD card connector on the internal dual SD module. Orient the SD card appropriately and insert the contact-pin end of the card into the slot.

 **NOTE:** The slot is keyed to ensure correct insertion of the card.

2. Press the card into the card slot to lock it into place.

#### Next steps

1. If removed, replace the cooling shroud.
2. Follow the procedure listed in [After working inside your system](#).

## Processors

### Removing a processor

#### Prerequisites

 **CAUTION:** Many repairs may only be done by a certified service technician. You should only perform troubleshooting and simple repairs as authorized in your product documentation, or as directed by the online or telephone service and support team. Damage due to servicing that is not authorized by Dell is not covered by your warranty. Read and follow the safety instructions that came with the product.

 **NOTE:** To ensure proper system cooling, you must install a processor blank in any empty processor socket.

1. Ensure that you read the [Safety instructions](#).
2. Keep the #2 Phillips screwdriver handy.
3. If you are upgrading your system, download the latest system BIOS version from [dell.com/support](http://dell.com/support) and follow the instructions included in the compressed download file to install the update on your system.

 **NOTE:** You can update the system BIOS using the Lifecycle Controller.

4. Follow the procedure listed in [Before working inside your system](#).
5. If installed, remove the cooling fan assembly.
6. If installed, remove the full-length PCIe card(s).
7. Remove the cooling shroud.

 **WARNING:** The heat sink and processor are hot to the touch for some time after the system has been powered down. Allow the heat sink and processor to cool before handling them.

 **CAUTION:** Never remove the heat sink from a processor unless you intend to remove the processor. The heat sink is necessary to maintain proper thermal conditions.

### Steps

1. To remove the heat sink:
  - a. Loosen one of the screws that secure the heat sink to the system board.  
Wait 30 seconds for the heat sink to loosen from the processor.
  - b. Remove the screw diagonally opposite the screw you first removed.
  - c. Repeat the procedure for the remaining two screws.
  - d. Remove the heat sink.

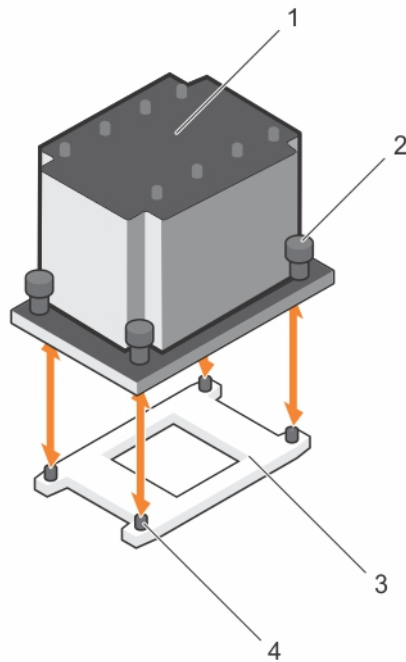

**Figure 34. Removing and installing a processor**

1. heat sink

2. captive screws (4)

3. processor socket

4. slots (4)

**⚠ CAUTION: The processor is held in its socket under strong pressure. Be aware that the release lever can spring up suddenly if not firmly grasped.**

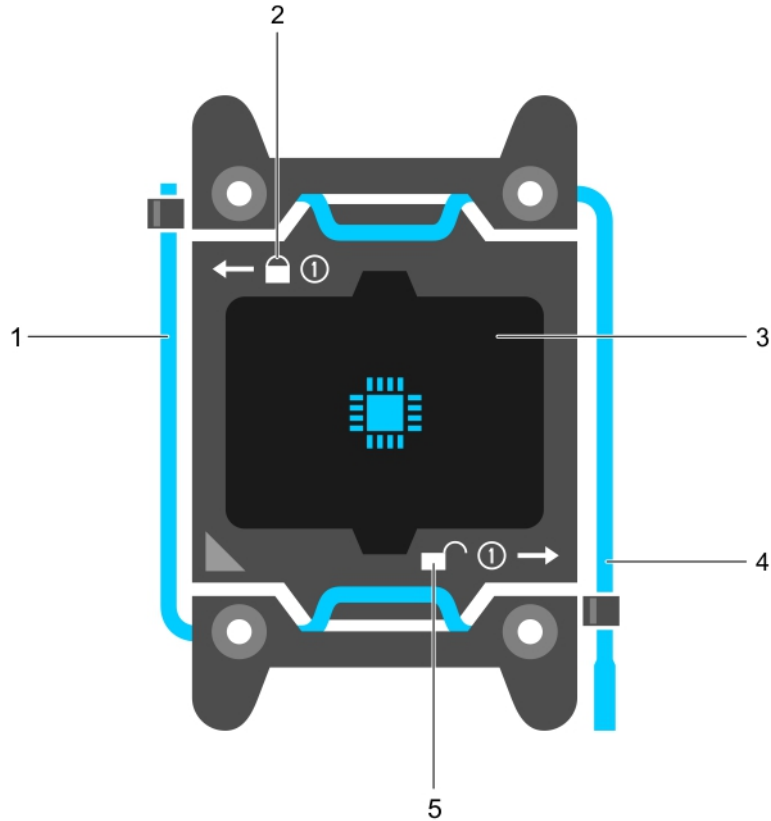

**Figure 35. Processor shield**

1. *close first* socket release lever



2. lock icon

3. processor

4. *open first* socket release lever

5. unlock icon

**2.** To remove the processor:

- a. Release the *open first* socket-lever near the unlock icon  by pushing the lever down and out from under the tab.
- b. Similarly, release the *close first* socket-release lever near the lock icon  by pushing the lever down and out from under the tab. Lift the lever 90 degrees upward.
- c. Lower the *open first* socket-release lever to lift the processor shield.

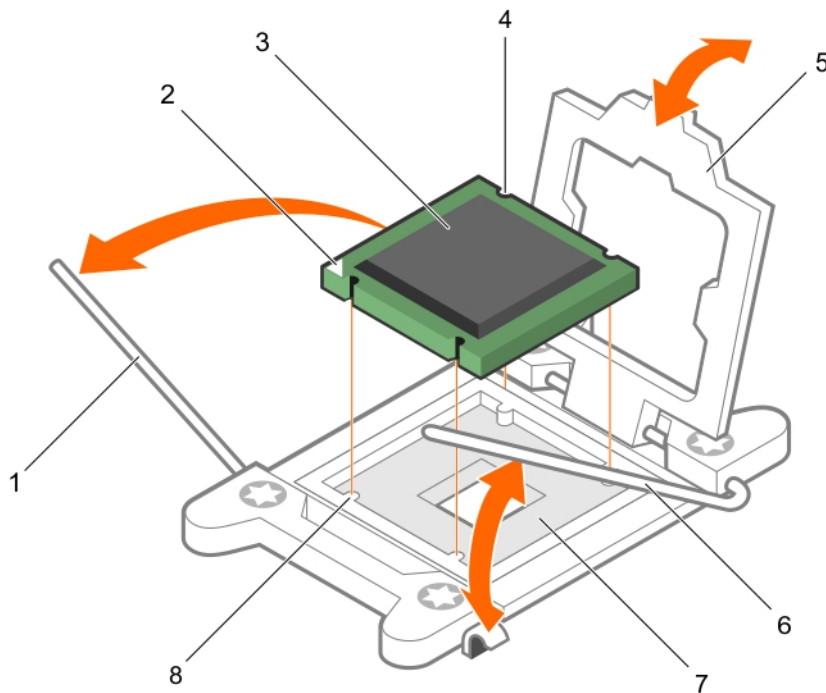

**Figure 36. Removing and installing a processor**

- |                                     |                                    |
|-------------------------------------|------------------------------------|
| 1. close first socket-release lever | 2. pin-1 indicator of processor    |
| 3. processor                        | 4. slot (4)                        |
| 5. processor shield                 | 6. open first socket-release lever |
| 7. socket                           | 8. socket keys (4)                 |

- d. Hold the tab on the processor shield and lift the processor shield until the *open first* socket-release lever lifts up.

**⚠ CAUTION: The socket pins are fragile and can be permanently damaged. Be careful not to bend the pins in the socket when removing the processor out of the socket.**

- e. Lift the processor out of the socket and leave the *open first* socket-release lever up.

**🔧 NOTE:** If you are permanently removing the processor, you must install a socket protective cap in the vacant socket to protect the socket pins and keep the socket free of dust.

**🔧 NOTE:** After removing the processor, place it in an anti-static container for reuse, return, or temporary storage. Do not touch the bottom of the processor. Touch only the side edges of the processor.

### Next steps

1. Replace the heat sink(s) and processor(s). See [Installing a processor](#).
2. Follow the procedure listed in [After working inside your system](#).

## Installing a processor

### Prerequisites

 **CAUTION:** Many repairs may only be done by a certified service technician. You should only perform troubleshooting and simple repairs as authorized in your product documentation, or as directed by the online or telephone service and support team. Damage due to servicing that is not authorized by Dell is not covered by your warranty. Read and follow the safety instructions that came with the product.

1. Ensure that you read the [Safety instructions](#).
2. Keep the #2 Phillips screwdriver handy.
3. If you are upgrading your system, download the latest system BIOS version from [dell.com/support](https://dell.com/support) and follow the instructions included in the compressed download file to install the update on your system.

 **NOTE:** You can update the system BIOS using the Lifecycle Controller.



4. Follow the procedure listed in [Before working inside your system](#).
5. If installed, remove the cooling fan assembly.
6. If installed, remove the full-length PCIe card.
7. Remove the cooling shroud.

 **WARNING:** The heat sink and processor are hot to the touch for some time after the system has been powered down. Allow the heat sink and processor to cool before handling them.

 **CAUTION:** Never remove the heat sink from a processor unless you intend to remove the processor. The heat sink is necessary to maintain proper thermal conditions.

 **NOTE:** If you are installing a single processor, it must be installed in socket CPU1.

### Steps

1. Unpack the new processor.  
If the processor has previously been used in a system, remove any remaining thermal grease from the processor using a lint-free cloth.
2. Locate the processor socket.
3. If applicable, remove the socket protective cap.
4. Release the *open first* socket-release lever near the unlock icon  by pushing the lever down and out from under the tab.
5. Similarly, release the *close first* socket-release lever near the lock icon  by pushing the lever down and out from under the tab. Lift the lever 90 degrees upward.
6. Hold the tab near the lock symbol on the processor shield and lift it up and out of the way.
7. To install the processor in the socket:

 **CAUTION:** Positioning the processor incorrectly can permanently damage the system board or the processor. Be careful not to bend the pins in the socket.



 **CAUTION:** While removing or reinstalling the processor, wipe your hands of any contaminants. Contaminants on the processor pins such as thermal grease or oil can damage the processor.

- a. Align the processor with the socket keys.

**△ CAUTION: Do not use force to seat the processor. When the processor is positioned correctly, it engages easily into the socket.**

- b. Align the pin-1 indicator of the processor with the triangle on the system board. .
- c. Place the processor on the socket such that the slots on the processor align with the socket keys.

**△ CAUTION: Do not use force to seat the processor. When the processor is positioned correctly, it engages easily into the socket.**

- d. Close the processor shield.
  - e. Lower the *close first* socket-release lever near the lock icon  and push it under the tab to lock it..
  - f. Similarly, lower the *open first* socket-release lever near the unlock icon  and push it under the tab to lock it.
- 8.** To install the heat sink:
- a. If applicable, remove the existing thermal grease from the heat sink using a clean lint-free cloth.
  - b. Apply thermal grease on the top of the processor. Use the thermal-grease syringe included with your processor kit to apply the grease in a thin spiral on the top of the processor as shown in the figure.

**△ CAUTION: Applying too much thermal grease can result in excess grease coming in contact with and contaminating the processor socket.**

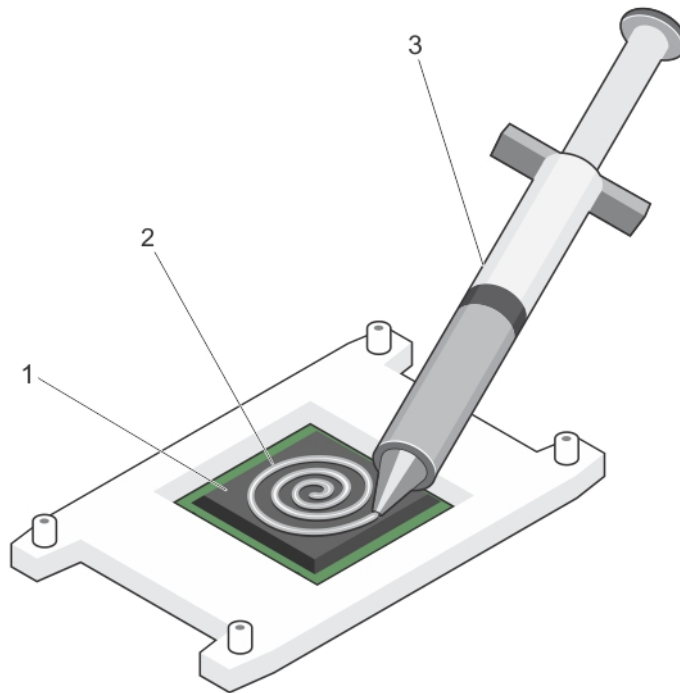

**Figure 37. Applying thermal grease on the top of the processor**

1. processor

2. thermal grease



### 3. thermal-grease syringe

 **NOTE:** The thermal-grease is intended for one-time use only. Dispose of the syringe after you use it.

- c. Place the heat sink onto the processor.
- d. Tighten the four screws to secure the heat sink to the system board.

 **NOTE:** Tighten the screws diagonally opposite to each other. Do not over-tighten the heat sink retention screws when installing the heat sink. To prevent over-tightening, tighten the retention screw until resistance is felt, and stop once the screw is seated. The screw tension should be no more than 6 in-lb (6.9 kg-cm).

#### Next steps

1. Install the cooling shroud.
2. If applicable, install the PCIe card.
3. If applicable, install the cooling fan assembly.
4. Follow the procedure listed in [After working inside your system](#).
5. While booting, press <F2> to enter the System Setup and check that the processor information matches the new system configuration.
6. Run the system diagnostics to verify that the new processor operates correctly.

## Power supplies

Your system supports either:

- Two 495 W, 750 W, 1100 W, or 1600 W (Platinum) AC power supply modules or
- Two 750 W (Titanium) AC power supply modules or
- Two 1100 W DC power supply modules

 **NOTE:** 495 W, 750 W, and 1100 W Platinum power supplies are nominally rated for 100 VAC to 240 VAC input.

750 W Titanium and 1600 W Platinum power supplies are nominally rated for 200 VAC to 240 VAC input.

1100 W DC power supply is nominally rated for –(48-60) VDC input.

 **NOTE:** When two identical power supplies are installed, power supply redundancy (1+1 – with redundancy or 2+0 – without redundancy) is configured in system BIOS. In redundant mode, power is supplied to the system equally from both power supplies when Hot Spare is disabled. When Hot Spare is enabled, one of the PSUs will be put into standby when system utilization is low in order to maximize efficiency.

 **CAUTION:** If two power supplies are used, they must be of the same maximum output power.

 **NOTE:** For AC power supplies, use only power supplies with the Extended Power Performance (EPP) label on the back. Mixing PSUs from previous generations of servers can result in a power supply mismatch condition or failure to power on.

 **NOTE:** When you have more than two GPU cards on your system, you will need two 1100 W PSUs installed on your system.

## Hot Spare feature

Your system supports the Hot Spare feature that significantly reduces the power overhead associated with power supply redundancy.

When the Hot Spare feature is enabled, one of the redundant power supplies is switched to a sleep state. The active power supply supports 100% of the load, thus operating at higher efficiency. The power supply in the sleep state monitors output voltage of the active power supply. If the output voltage of the active power supply drops, the power supply in the sleep state returns to an active output state.

If having both power supplies active is more efficient than having one power supply in a sleep state, the active power supply can also activate a sleeping power supply.

The default power supply settings are as follows:

- If the load on the active power supply is more than 50%, then the redundant power supply is switched to the active state.
- If the load on the active power supply falls below 20%, then the redundant power supply is switched to the sleep state

You can configure the Hot Spare feature using the iDRAC settings. For more information on iDRAC settings, see the Integrated Dell Remote Access Controller User's Guide at [dell.com/support/manuals](https://dell.com/support/manuals).

## Removing an AC power supply unit

### Prerequisites

 **CAUTION:** Many repairs may only be done by a certified service technician. You should only perform troubleshooting and simple repairs as authorized in your product documentation, or as directed by the online or telephone service and support team. Damage due to servicing that is not authorized by Dell is not covered by your warranty. Read and follow the safety instructions that came with the product.

 **CAUTION:** The system requires one power supply for normal operation. On power-redundant systems, remove and replace only one power supply at a time in a system that is powered on.

 **NOTE:** You may have to unlatch and lift the optional cable management arm if it interferes with power supply removal. For information about the cable management arm, see the system's rack documentation.

### Steps

1. Disconnect the power cable from the power source and from the power supply unit you intend to remove and remove the cables from the strap.
2. Press the release latch and slide the power supply unit out of the chassis.

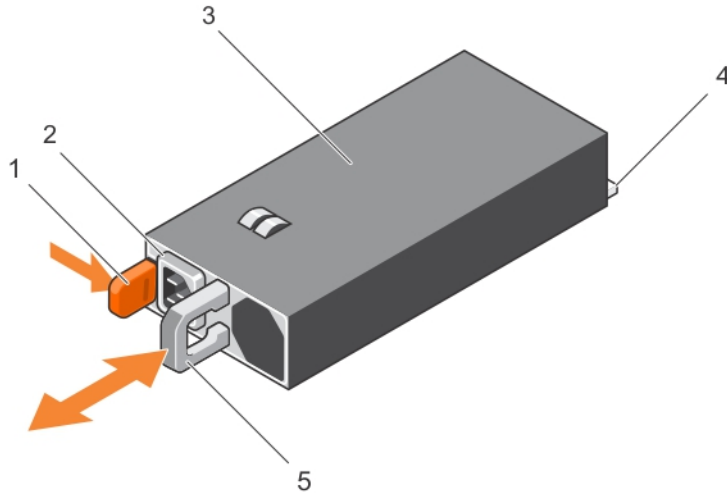

**Figure 38. Removing and installing an AC power supply unit**

- |                             |                                      |
|-----------------------------|--------------------------------------|
| 1. release latch            | 2. power supply unit cable connector |
| 3. power supply unit        | 4. connector                         |
| 5. power supply unit handle |                                      |

## Installing an AC power supply unit

### Prerequisites

**⚠ CAUTION:** Many repairs may only be done by a certified service technician. You should only perform troubleshooting and simple repairs as authorized in your product documentation, or as directed by the online or telephone service and support team. Damage due to servicing that is not authorized by Dell is not covered by your warranty. Read and follow the safety instructions that came with the product.





### Steps

1. Verify that both the power supply units are the same type and have the same maximum output power.
  - 🔧 NOTE:** The maximum output power (shown in watts) is listed on the power supply label.
2. If applicable, remove the power supply unit blank.
3. Slide the new power supply unit into the chassis until the power supply unit is fully seated and the release latch snaps into place.
  - 🔧 NOTE:** If you unlatched the cable management arm, re-latch it. For information about the cable management arm, see the system's rack documentation.
4. Connect the power cable to the power supply unit and plug the cable into a power outlet.
  - ⚠ CAUTION:** When connecting the power cable, secure the cable with the strap.

-  **NOTE:** When installing, hot-swapping, or hot-adding a new power supply unit, wait for 15 seconds for the system to recognize the power supply unit and determine its status. The power supply redundancy may not occur until discovery is complete. Wait until the new power supply unit is discovered and enabled before you remove the other power supply unit. The power-supply unit status indicator turns green to signify that the power supply unit is functioning properly.

## Wiring instructions for a DC power supply unit

Your system supports up to two –(48–60) V DC power supplies (when available).

-  **WARNING:** For equipment using –(48–60) V DC power supplies, a qualified electrician must perform all connections to DC power and to safety grounds. Do not attempt connecting to DC power or installing grounds yourself. All electrical wiring must comply with applicable local or national codes and practices. Damage due to servicing that is not authorized by Dell is not covered by your warranty. Read and follow all safety instructions that came with the product.
-  **CAUTION:** Wire the unit with copper only, unless otherwise specified, use only 10 American Wire Gauge (AWG) wire rated minimum 90 °C for source and return. Protect the –(48–60) V DC (1 wire) with a branch circuit over-current protection rated 50 A for DC with a high interrupt current rating.
-  **CAUTION:** Connect the equipment to a –(48–60) V DC supply source that is electrically isolated from the AC source (reliably grounded –(48–60) V DC SELV source). Ensure that the –(48–60) V DC source is efficiently secured to earth (ground).
-  **NOTE:** A readily accessible disconnect device that is suitably approved and rated shall be incorporated in the field wiring.

### Input requirements

- Supply voltage: –(48–60) V DC
- Current consumption: 32 A (maximum)

### Kit contents

- Dell part number 6RYJ9 terminal block or equivalent (1)
- #6-32 nut equipped with lock washer (1)

### Required tools

Wire-stripper pliers capable of removing insulation from size 10 AWG solid or stranded, insulated copper wire

-  **NOTE:** Use alpha wire part number 3080 or equivalent (65/30 stranding)

### Required wires

- One UL 10 AWG, 2 m maximum (stranded) black wire [–(48–60) V DC]
- One UL 10 AWG, 2 m maximum (stranded) red wire (V DC return)
- One UL 10 AWG, 2 m maximum green/yellow, green with a yellow stripe, stranded wire (safety ground)

## Assembling and connecting the safety ground wire

### Prerequisites

**⚠ WARNING:** For equipment using  $-(48-60)$  V DC power supplies, a qualified electrician must perform all connections to DC power and to safety grounds. Do not attempt connecting to DC power or installing grounds yourself. All electrical wiring must comply with applicable local or national codes and practices. Damage due to servicing that is not authorized by Dell is not covered by your warranty. Read and follow all safety instructions that came with the product.

### Steps

1. Strip the insulation from the end of the green/yellow wire, exposing approximately 4.5 mm (0.175 inch) of copper wire.
2. Using a hand-crimping tool (Tyco Electronics, 58433-3 or equivalent), crimp the ring-tongue terminal (Jeeson Terminals Inc., R5-4SA or equivalent) to the green/yellow wire (safety ground wire).
3. Connect the safety ground wire to the grounding post on the back of the system using a #6-32 nut equipped with a locking washer.

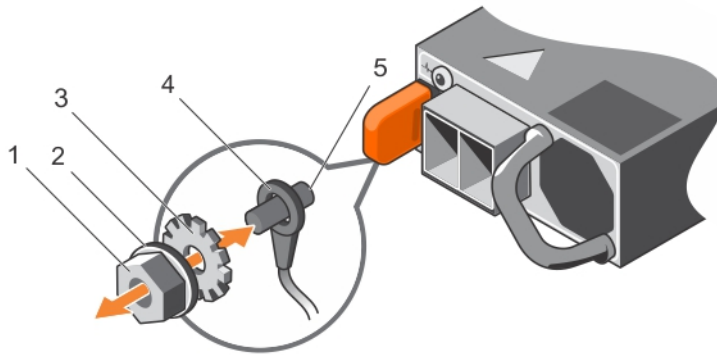

Figure 39. Assembling and connecting the safety ground wire

- |                   |                       |
|-------------------|-----------------------|
| 1. #6-32 nut      | 2. spring washer      |
| 3. locking washer | 4. safety ground wire |
| 5. grounding post |                       |

## Assembling the DC input power wires

### Prerequisites

**⚠ WARNING:** For equipment using  $-(48-60)$  V DC power supplies, a qualified electrician must perform all connections to DC power and to safety grounds. Do not attempt connecting to DC power or installing grounds yourself. All electrical wiring must comply with applicable local or national codes and practices. Damage due to servicing that is not authorized by Dell is not covered by your warranty. Read and follow all safety instructions that came with the product.

## Steps

1. Strip the insulation from the ends of the DC power wires, exposing approximately 13 mm (0.5 inch) of copper wire.

**⚠ WARNING: Reversing polarity when connecting DC power wires can permanently damage the power supply or the system.**

2. Insert the copper ends into the mating connectors and tighten the captive screws at the top of the mating connector using a #2 Phillips screwdriver.

**⚠ WARNING: To protect the power supply from electrostatic discharge, the captive screws must be covered with the rubber cap before inserting the mating connector into the power supply.**

3. Rotate the rubber cap clockwise to fix it over the captive screws.
4. Insert the mating connector into the power supply.

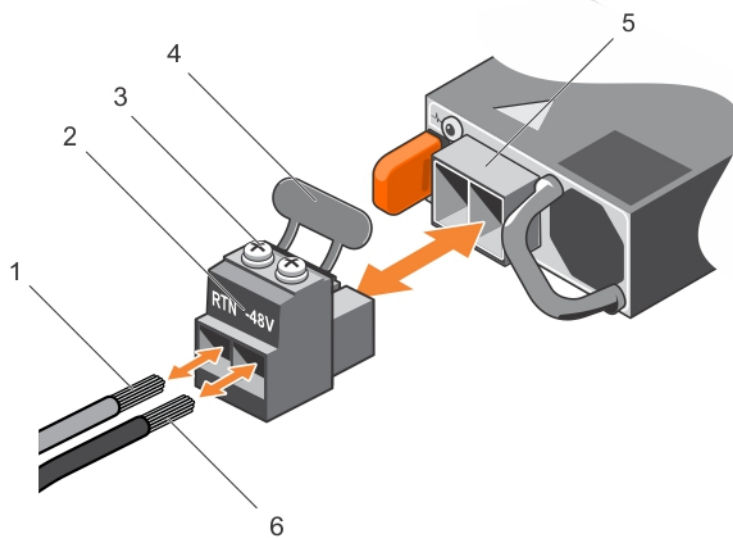

Figure 40. Assembling the DC input power wires

- |                       |                       |
|-----------------------|-----------------------|
| 1. wire RTN           | 2. DC power connector |
| 3. captive screws (2) | 4. rubber cap         |
| 5. DC power socket    | 6. wire -48 V         |

## Removing a DC power supply unit

### Prerequisites

**⚠ WARNING: For equipment using -(48–60) V DC power supplies, a qualified electrician must perform all connections to DC power and to safety grounds. Do not attempt connecting to DC power or installing grounds yourself. All electrical wiring must comply with applicable local or national codes and practices. Damage due to servicing that is not authorized by Dell is not covered by your warranty. Read and follow all safety instructions that came with the product.**

**⚠ CAUTION: The system requires one power supply for normal operation. On power-redundant systems, remove and replace only one power supply at a time in a system that is powered on.**

**NOTE:** You may have to unlatch and lift the optional cable management arm if it interferes with power supply removal. For information about the cable management arm, see the system's rack documentation.

### Steps

1. Disconnect the power wires from the power source and the connector from the power supply you intend to remove.
2. Disconnect the safety ground wire.
3. Press the release latch and slide the power supply out of the chassis.

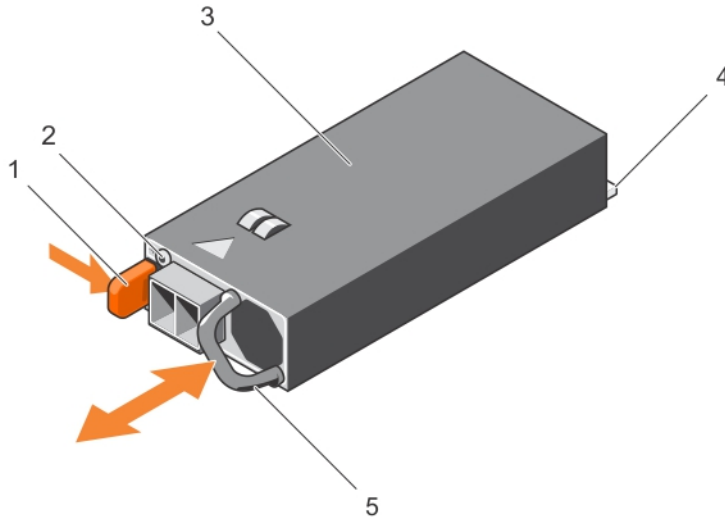

**Figure 41. Removing and installing a DC power supply**

- |                        |                                  |
|------------------------|----------------------------------|
| 1. release latch       | 2. power supply status indicator |
| 3. power supply        | 4. connector                     |
| 5. power supply handle |                                  |

## Installing a DC power supply unit

### Prerequisites

**WARNING:** For equipment using  $-(48-60)$  V DC power supplies, a qualified electrician must perform all connections to DC power and to safety grounds. Do not attempt connecting to DC power or installing grounds yourself. All electrical wiring must comply with applicable local or national codes and practices. Damage due to servicing that is not authorized by Dell is not covered by your warranty. Read and follow all safety instructions that came with the product.

### Steps

1. Verify that both the power supplies are of the same type and have the same maximum output power.
  - NOTE:** The maximum output power (shown in watts) is listed on the power supply label.
2. If installed, remove the power supply blank.
3. Slide the new power supply unit into the chassis until the power supply unit is fully seated and the release latch snaps into place.

 **NOTE:** If you unlatched the cable management arm, relatch it. For information about the cable management arm, see the system's rack documentation.

4. Connect the safety ground wire.
5. Install the DC power connector in the power supply unit.

 **CAUTION:** When connecting the power wires, secure the wires with the strap to the power supply handle.

6. Connect the wires to a DC power source.

 **NOTE:** When installing, hot-swapping, or hot-adding a new power supply, wait for 15 seconds for the system to recognize the power supply and determine its status. The power-supply status indicator turns green to signify that the power supply is functioning properly.

## Removing the power supply unit blank

If you are installing a second power supply unit, remove the power supply unit blank in the bay by pulling the blank outward.

 **CAUTION:** To ensure proper system cooling, the power supply blank must be installed in the second power supply bay in a non-redundant configuration. Remove the power supply blank only if you are installing a second power supply.



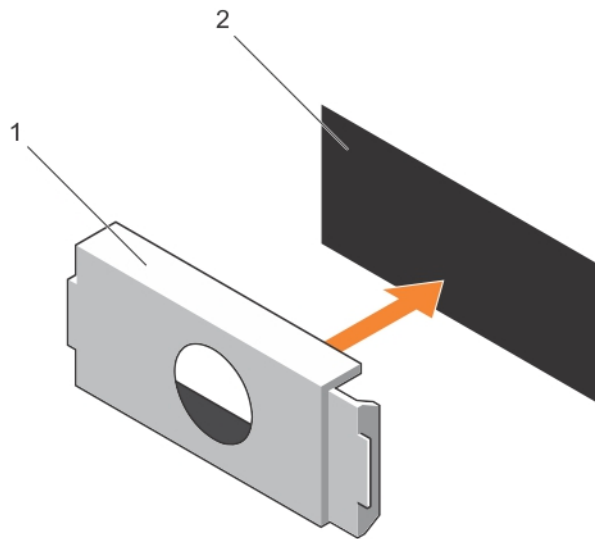

**Figure 42. Removing and installing the power supply blank**

1. power supply blank
2. power supply bay

## Installing the power supply unit blank

Install the power supply unit blank only in the second power supply unit bay.

To install the power supply unit blank, align the blank with the power supply unit bay and push it into the chassis until it clicks into place.

## System battery

### Replacing the system battery

#### Prerequisites

1. Ensure that you read the [Safety instructions](#).
2. Follow the procedure listed in [Before working inside your system](#).
3. Remove the cooling shroud.

**⚠ WARNING:** There is a danger of a new battery exploding if it is incorrectly installed. Replace the battery only with the same or equivalent type recommended by the manufacturer. See your safety information for additional information.

**⚠ CAUTION:** Many repairs may only be done by a certified service technician. You should only perform troubleshooting and simple repairs as authorized in your product documentation, or as directed by the online or telephone service and support team. Damage due to servicing that is not authorized by Dell is not covered by your warranty. Read and follow the safety instructions that came with the product.

#### Steps

1. Locate the battery socket. For more information, see [System Board Connectors](#).

**⚠ CAUTION: To avoid damage to the battery connector, you must firmly support the connector while installing or removing a battery.**

2. To remove the battery, press firmly on the edge of the positive side of the battery in the direction of the arrow as shown in the illustration below.

The battery ejects from the socket.

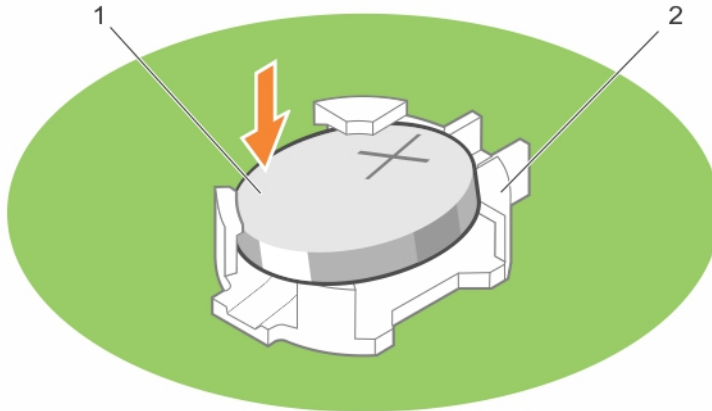

**Figure 43. Removing and installing the system battery**

1. positive side of battery
2. socket

3. To install a new system battery, hold the battery with the positive side facing up and slide it under the securing tabs.
4. Press the battery into the connector until it snaps into place.

#### Next steps

1. Install the cooling shroud.
2. Follow the procedure listed in [After working inside your system](#).
3. While booting your system, press <F2> to enter the System Setup and ensure the battery is operating properly.
4. Enter the correct time and date in the System Setup **Time** and **Date** fields.
5. Exit the System Setup.

## Hard-drive backplane

Depending on your configuration, your system supports one of the following:

- 3.5 inch x8 SAS/SATA backplane
- 3.5 inch x18 SAS/SATA backplane
- 2.5 inch x4 Dell PowerEdge Express Flash (PCIe SSD) backplane
- 2.5 inch x16 SAS/SATA backplane

- 2.5 inch x32 SAS/SATA backplane

Depending on your configuration, your system supports one of the following backplane combinations:

- 3.5 inch x8 SAS/SATA backplane and 2.5 inch x4 PCIe SSD backplane
- 2.5 inch x16 SAS/SATA backplane and 2.5 inch x4 PCIe SSD backplane
- 2.5 inch x16 SAS/SATA backplane for hard-drives in the hard-drive bay and 2.5 inch x16 SAS/SATA backplane for hard-drives in a flex bay.

## Removing the hard-drive backplane

### Prerequisites

1. Ensure that you read the [Safety instructions](#).
2. Follow the procedure listed in [Before working inside your system](#).
3. Remove all hard drives.
4. Remove the cooling shroud.
5. If applicable, remove the cooling-fan assembly.

 **CAUTION:** Many repairs may only be done by a certified service technician. You should only perform troubleshooting and simple repairs as authorized in your product documentation, or as directed by the online or telephone service and support team. Damage due to servicing that is not authorized by Dell is not covered by your warranty. Read and follow the safety instructions that came with the product.

 **CAUTION:** To prevent damage to the drives and backplane, you must remove the hard drives from the system before removing the backplane.

 **CAUTION:** You must note the number of each hard drive and temporarily label them before removal so that you can replace them in the same locations.

### Steps

1. Disconnect the SAS/SATA/SSD data, signal, and power cable(s) from the backplane.
2. Pull the release pin or the release tab and pull the backplane up and out from the system.

 **NOTE:** For a Dell PowerEdge Express Flash (PCIe SSD) backplane, press the release tab to unlock the hard-drive backplane and release it from the hard-drive bay.

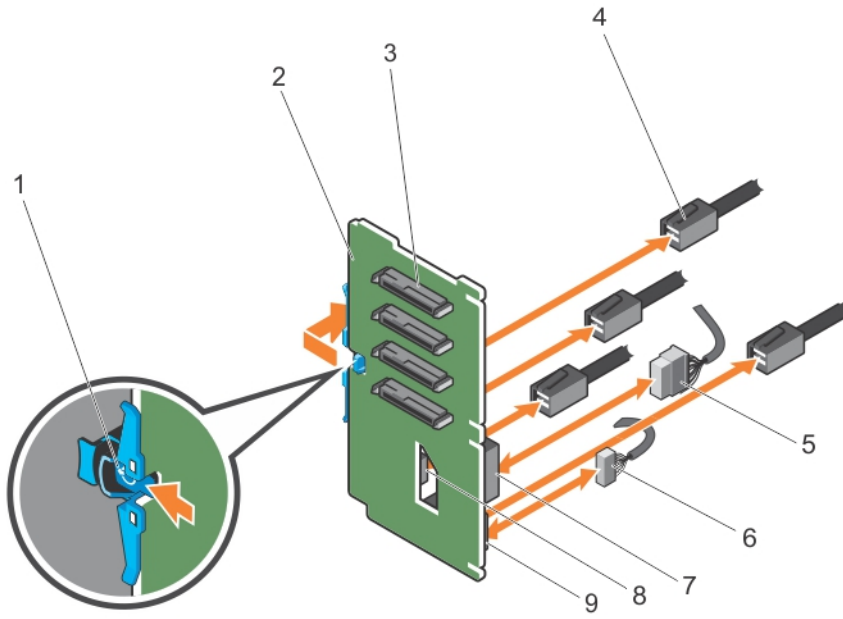

**Figure 44. Removing and installing the PCIe SSD hard-drive backplane**

- |  |                                      |
|--|--------------------------------------|
| 1. release tab                         | 2. PCIe SSD hard-drive backplane     |
| 3. hard-drive connector                | 4. PCIe cable                        |
| 5. power cable                         | 6. signal cable                      |
| 7. power connector on backplane        | 8. PCIe cable connector on backplane |
| 9. signal cable connector on backplane |                                      |

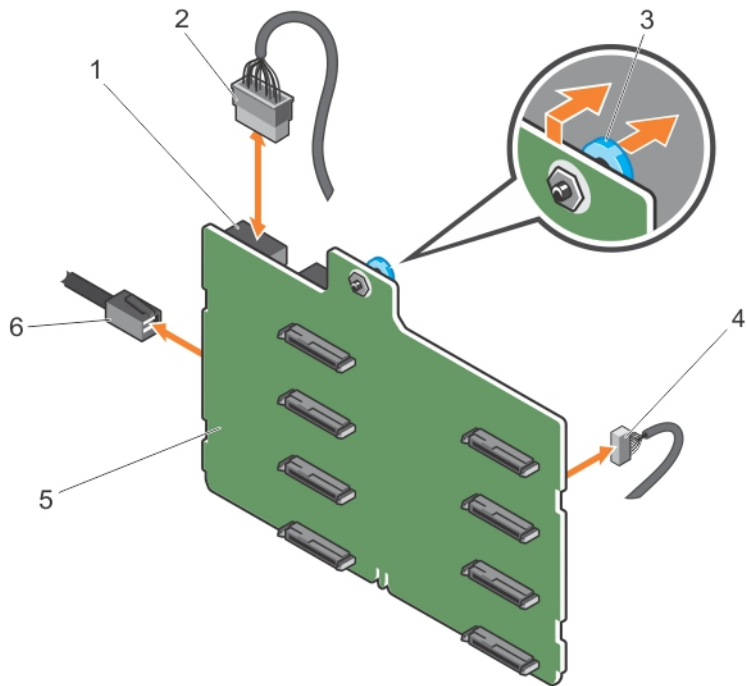

**Figure 45. Removing and installing a 3.5 inch (x8) SAS/SATA backplane**

- |                              |                          |
|------------------------------|--------------------------|
| 1. backplane power connector | 2. backplane power cable |
| 3. release pin               | 4. signal cable          |
| 5. x8 backplane              | 6. SAS cable             |

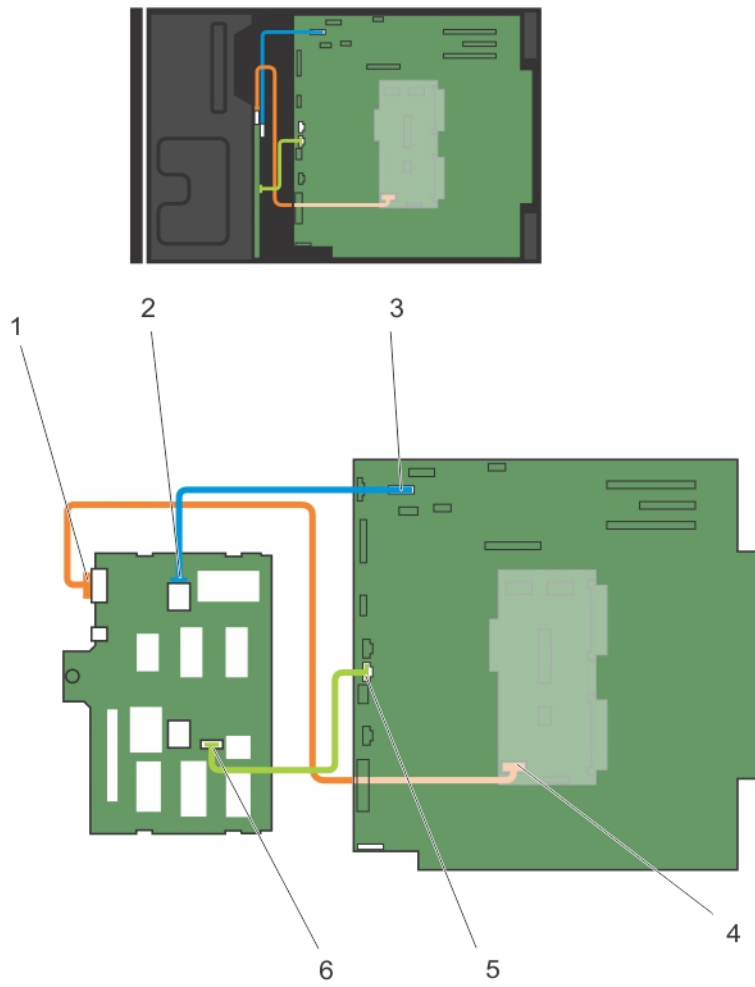

**Figure 46. Cabling—3.5 inch (x8) SAS/SATA backplane**

- |                                     |                                  |
|-------------------------------------|----------------------------------|
| 1. power connector on backplane     | 2. SAS A connector on backplane  |
| 3. SAS A connector on system board  | 4. power connector on PDB        |
| 5. signal connector on system board | 6. signal connector on backplane |

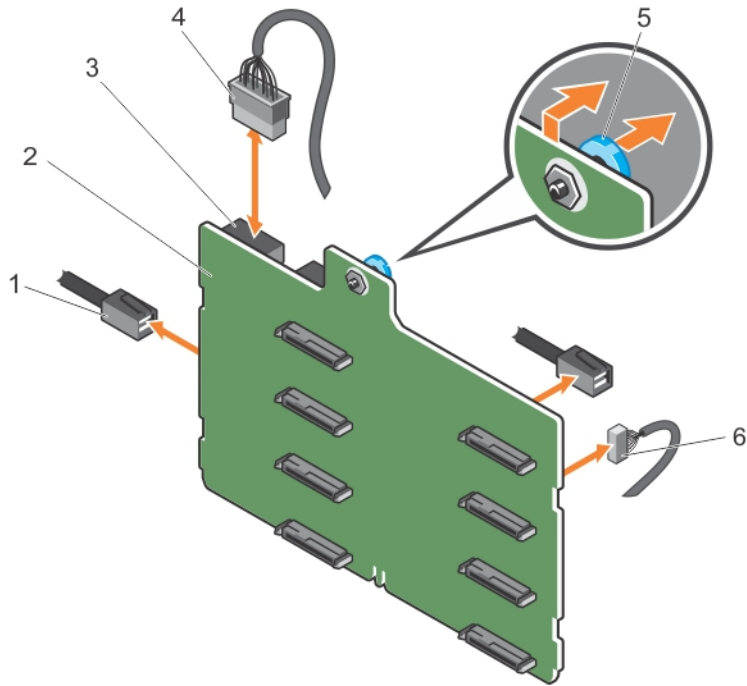

**Figure 47. Removing and installing a 3.5 inch (x8) SAS/SATA backplane with a single PERC card**

- |                    |                 |
|--------------------|-----------------|
| 1. SAS cable       | 2. x8 backplane |
| 3. power connector | 4. power cable  |
| 5. release pin     | 6. signal cable |

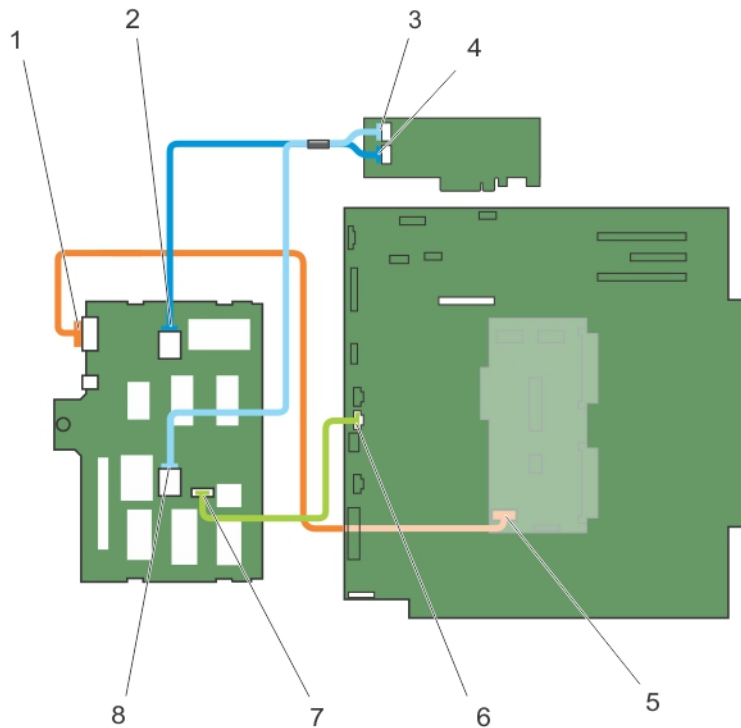
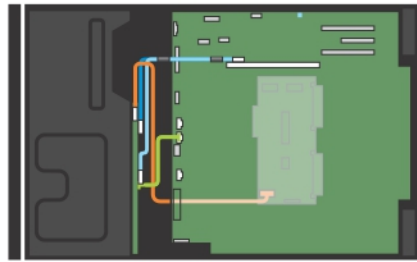

**Figure 48. Cabling—3.5 inch (x8) SAS/SATA backplane with a single PERC card**

- |                                  |                                     |
|----------------------------------|-------------------------------------|
| 1. power connector on backplane  | 2. SAS A connector on backplane     |
| 3. SAS B connector on PERC card  | 4. SAS A connector on PERC card     |
| 5. power connector on PDB        | 6. signal connector on system board |
| 7. signal connector on backplane | 8. SAS B connector on backplane     |



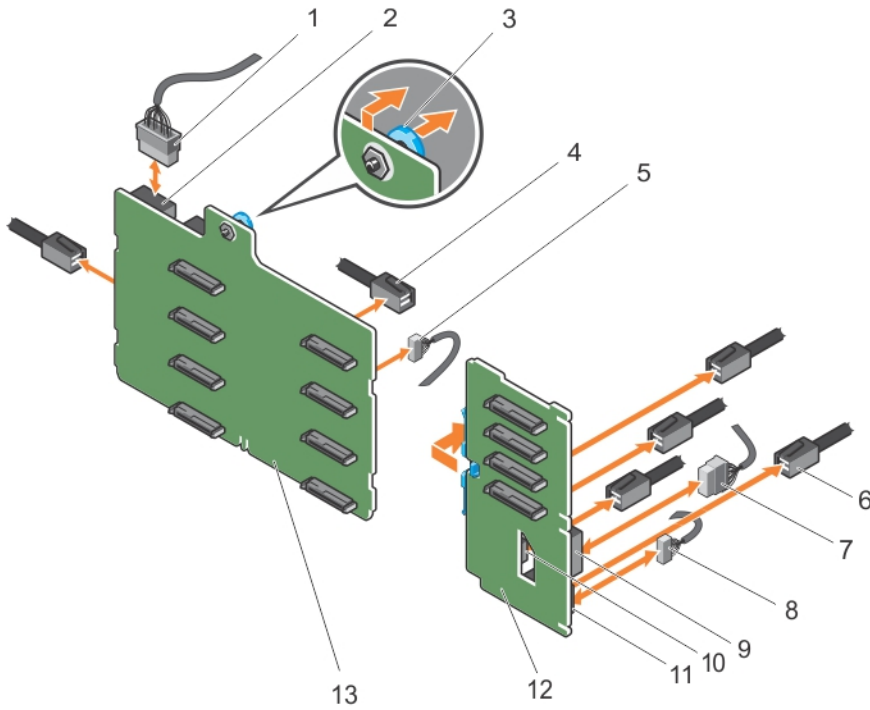

**Figure 49. Removing and installing a 3.5 inch (x8) plus 2.5 Inch (x4) SAS/SATA backplane**

- |  |  |
|--|--|
| 1. x8 backplane power cable                | 2. power connector on x8 backplane             |
| 3. release pin                             | 4. SAS cable on x8 backplane                   |
| 5. signal cable on x8 backplane            | 6. PCIe cable on PCIe SSD backplane            |
| 7. power cable on PCIe SSD backplane       | 8. signal cable on PCIe SSD backplane          |
| 9. power connector on PCIe SSD backplane   | 10. PCIe cable connector on PCIe SSD backplane |
| 11. signal connector on PCIe SSD backplane | 12. PCIe SSD backplane                         |
| 13. x8 backplane                           |  |

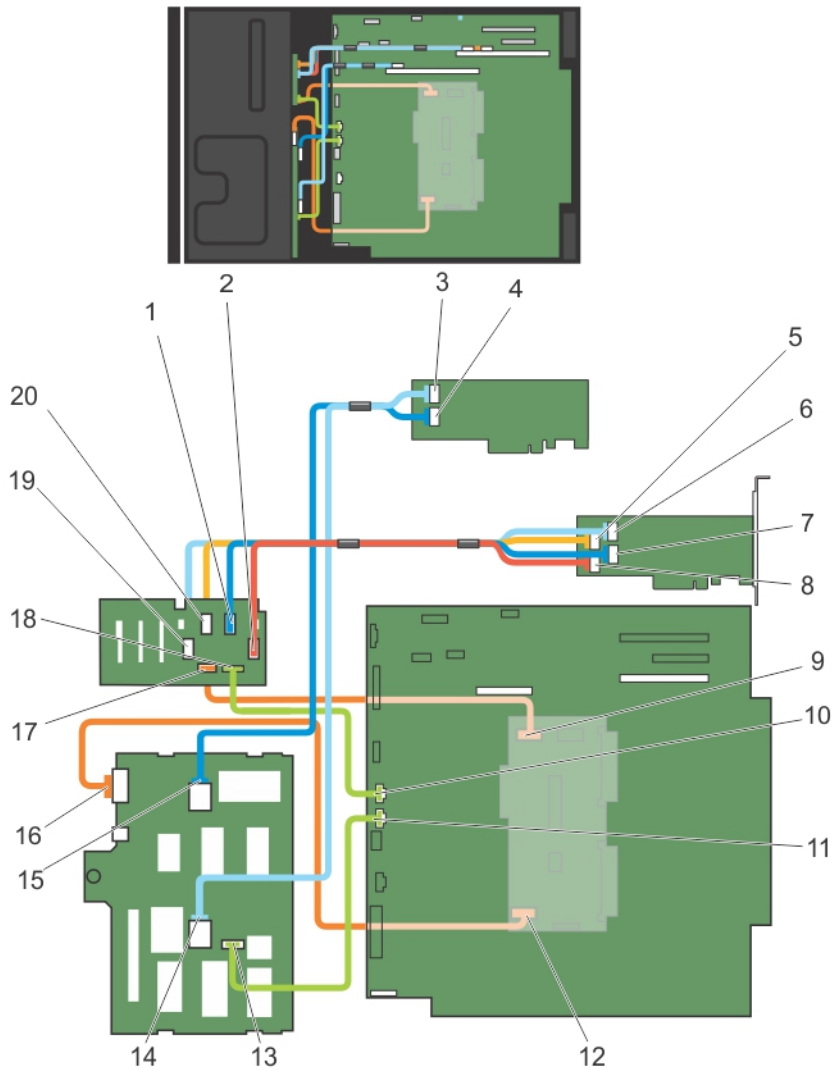

**Figure 50. Cabling—3.5 Inch (x8) plus 2.5 inch (x4) SAS/SATA backplane**

1. PCIe B connector on PCIe SSD backplane
2. PCIe D connector on PCIe SSD backplane
3. SAS B cable from 3.5 inch backplane on PERC card
4. SAS A cable from 3.5 inch backplane on PERC card
5. PCIe A cable from PCIe SSD backplane to PCIe extender card
6. PCIe C cable from PCIe SSD backplane to PCIe extender card
7. PCIe B cable from PCIe SSD backplane to PCIe extender card
8. PCIe D cable from PCIe SSD backplane to PCIe extender card
9. PCIe SSD backplane power connector on PDB
10. PCIe SSD backplane signal connector on system board

11. x8 backplane signal connector on system board
12. x8 backplane power cable
13. x8 backplane signal cable
14. SAS B cable on x8 backplane
15. SAS A cable on x8 backplane
16. x8 backplane power cable
17. power connector on PCIe SSD backplane
18. PCIe SSD backplane signal cable
19. PCIe C cable on PCIe SSD backplane
20. PCIe A cable on PCIe SSD backplane

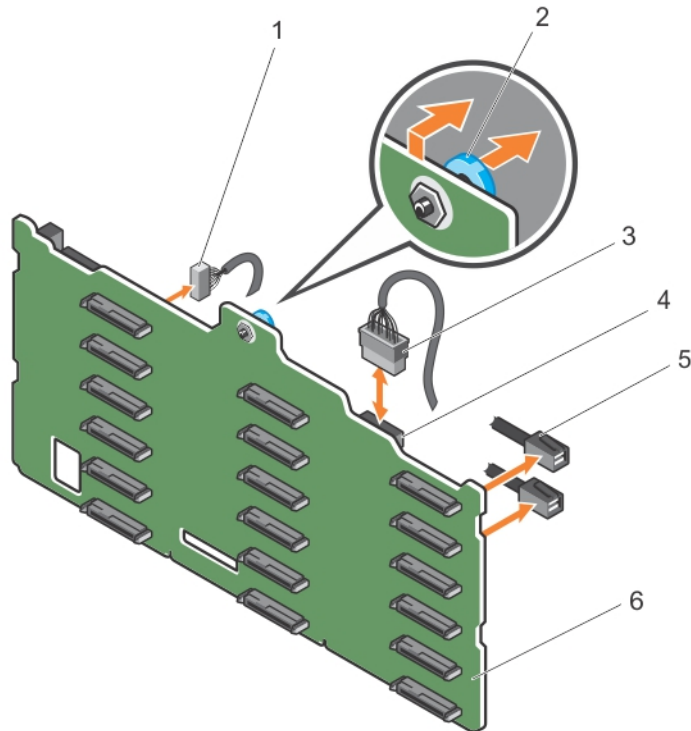

**Figure 51. Removing and installing a 3.5 inch (x18) SAS/SATA backplane**

- |                 |                    |
|-----------------|--------------------|
| 1. signal cable | 2. release pin     |
| 3. power cable  | 4. power connector |
| 5. SAS cable    | 6. x18 backplane   |

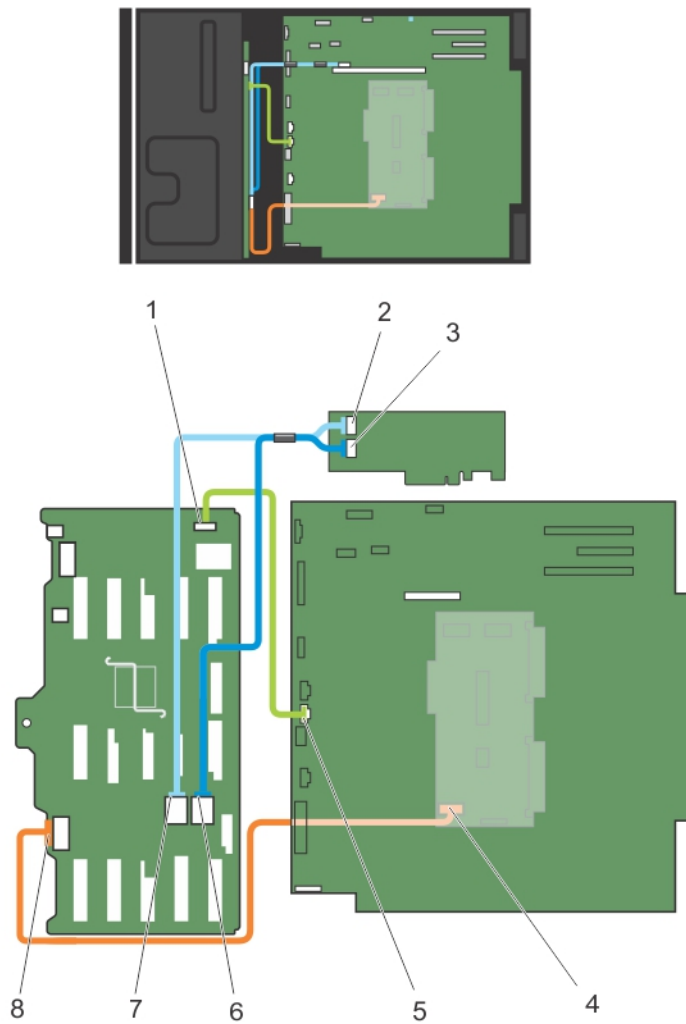

**Figure 52. Cabling—3.5 inch (x18) SAS/SATA backplane**

1. signal connector on backplane
2. SAS A connector on PERC card
3. SAS B connector on PERC card
4. power connector on PDB
5. signal connector on system board
6. SAS B connector on backplane
7. SAS A connector on backplane
8. power connector on backplane

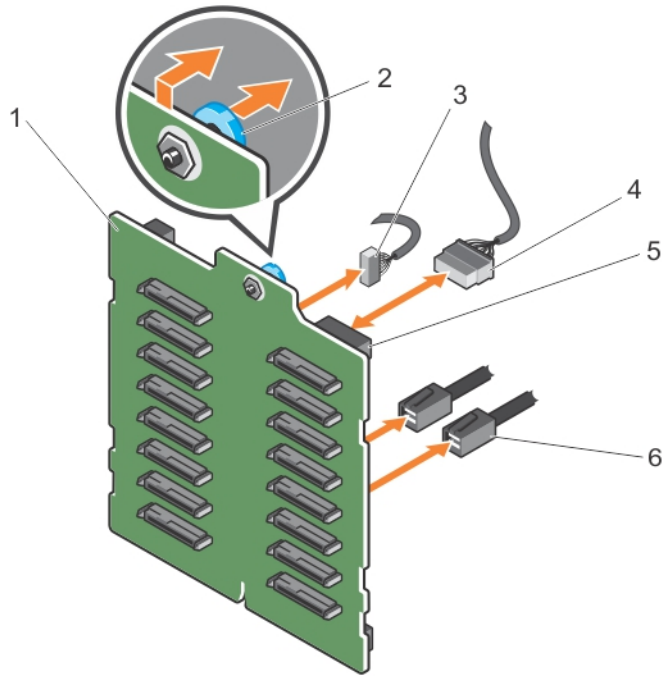

**Figure 53. Removing and installing 2.5 inch (x16) SAS/SATA backplane**

- |                    |                |
|--------------------|----------------|
| 1. x16 backplane   | 2. release pin |
| 3. signal cable    | 4. power cable |
| 5. power connector | 6. SAS cable   |

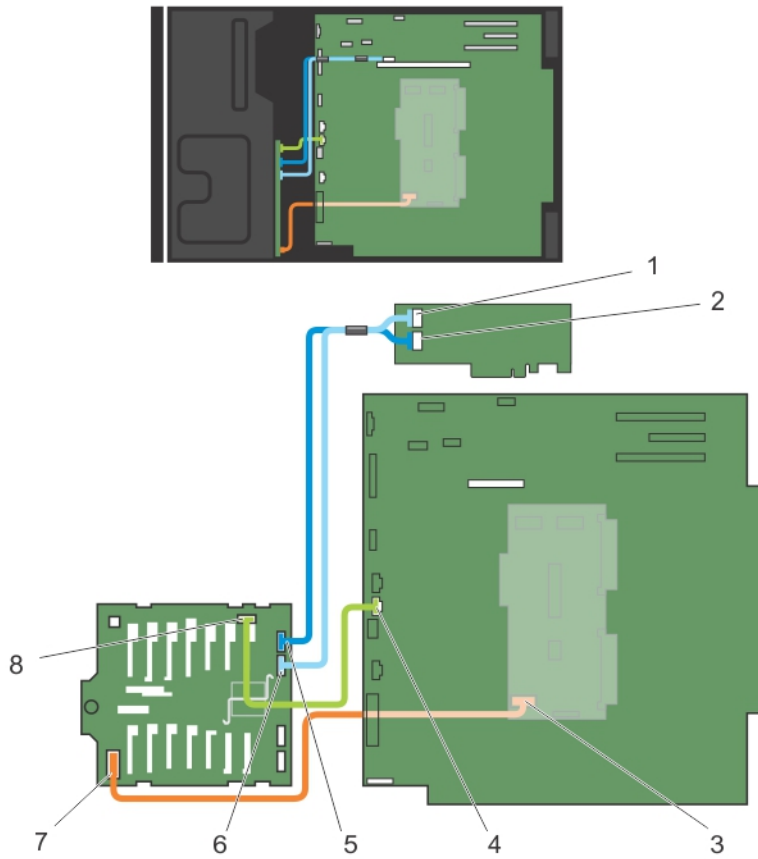

**Figure 54. Cabling—2.5 inch (x16) SAS/SATA backplane**

- |                                 |                                     |
|---------------------------------|-------------------------------------|
| 1. SAS A connector on PERC      | 2. SAS B connector on PERC          |
| 3. power connector on PDB       | 4. signal connector on system board |
| 5. SAS B connector on backplane | 6. SAS A connector on backplane     |
| 7. power connector on backplane | 8. signal connector on backplane    |

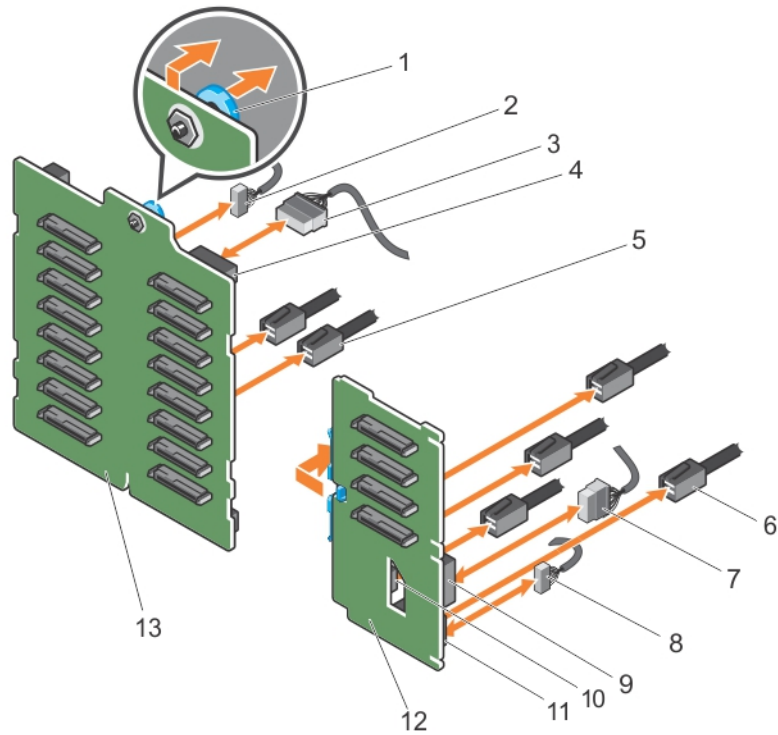

**Figure 55. Removing and installing 2.5 inch (x16) plus 2.5 Inch (x4) SAS/SATA backplane**

- |  |   |
|--|---|
| 1. release pin                             | 2. signal cable to x16 backplane        |
| 3. power cable to x16 backplane            | 4. power connector on x16 backplane     |
| 5. SAS cable to x16 backplane              | 6. SAS cable to PCIe SSD backplane      |
| 7. power cable to PCIe SSD backplane       | 8. signal cable to PCIe SSD backplane   |
| 9. power connector on PCIe SSD backplane   | 10. SAS connector on PCIe SSD backplane |
| 11. signal connector on PCIe SSD backplane | 12. PCIe SSD backplane                  |
| 13. x16 backplane                          |   |

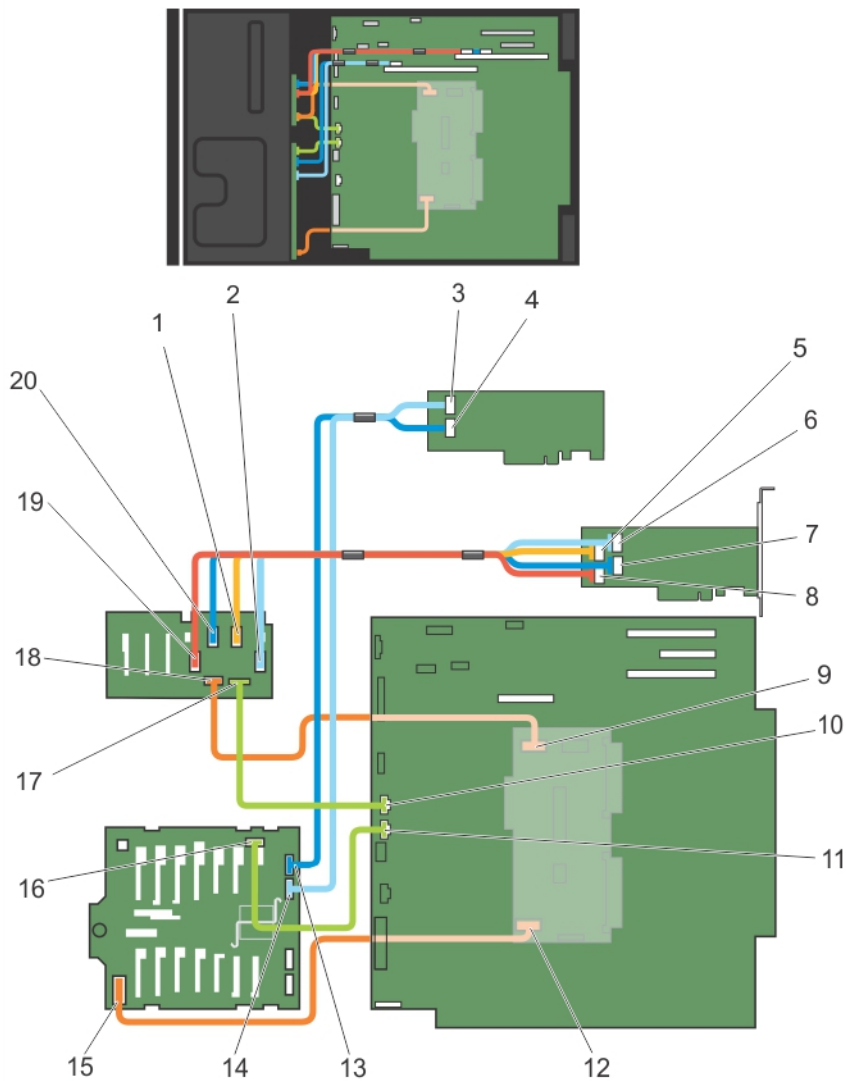
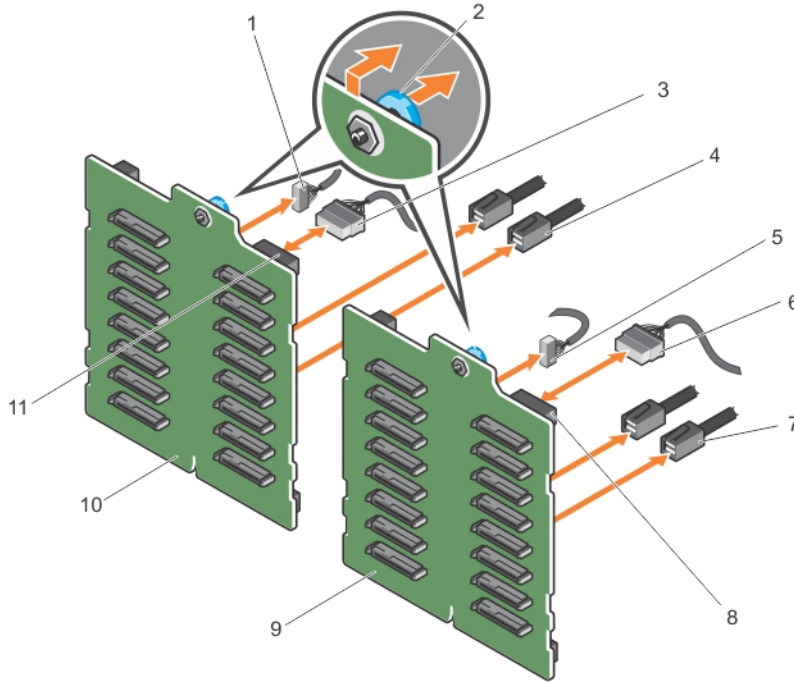

**Figure 56. Cabling—2.5 inch (x16) plus 2.5 inch (x4) SAS/SATA backplane**

- |  |   |
|--|---|
| 1. PCIe B cable on PCIe SSD backplane              | 2. PCIe D cable on PCIe SSD backplane                   |
| 3. SAS B connector on PERC                         | 4. SAS A connector on PERC                              |
| 5. PCIe B cable PCIe bridge card                   | 6. PCIe D cable on PCIe bridge card                     |
| 7. PCIe A cable on PCIe bridge card                | 8. PCIe C cable on PCIe bridge card                     |
| 9. PCIe SSD backplane power connector on PDB       | 10. PCIe SSD backplane signal connector on system board |
| 11. x16 backplane signal connector on system board | 12. x16 backplane power connector on PDB                |
| 13. SAS A connector on x16 backplane               | 14. SAS B connector on x16 backplane                    |
| 15. power connector on x16 backplane               | 16. signal connector on x16 backplane                   |



- 17. signal connector on PCIe SSD backplane
- 18. power connector on PCIe SSD backplane
- 19. PCIe C cable on PCIe SSD backplane
- 20. PCIe A cable on PCIe SSD backplane



**Figure 57. Removing and installing 2.5 inch (x32) SAS/SATA backplane with two PERC cards**

- 1. signal cable to backplane 2
- 2. release pin
- 3. power cable to backplane 2
- 4. SAS cable to backplane 2
- 5. signal cable to backplane 1
- 6. power cable to backplane 1
- 7. SAS cable to backplane 1
- 8. power connector on backplane 1
- 9. x16 backplane 1
- 10. x16 backplane 2
- 11. power connector on backplane 2

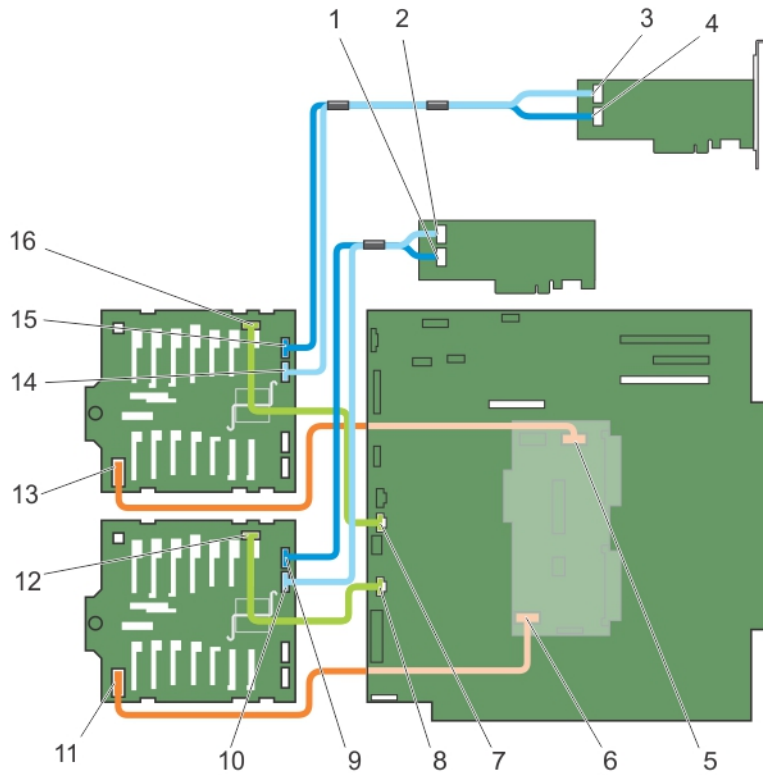
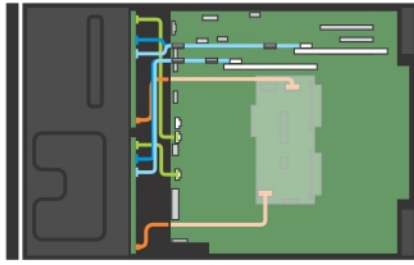

**Figure 58. Cabling—2.5 inch (x32) SAS/SATA backplane with two PERC cards**

- |  |  |
|--|--|
| 1. SAS A connector on 1st PERC                   | 2. SAS B connector on 1st PERC                   |
| 3. SAS B connector on 2nd PERC                   | 4. SAS A connector on 2nd PERC                   |
| 5. backplane 2 power connector on PDB            | 6. backplane 1 power connector on PDB            |
| 7. signal cable from backplane 1 on system board | 8. signal cable from backplane 2 on system board |
| 9. SAS A connector on backplane 1                | 10. SAS B connector on backplane 1               |
| 11. power connector on backplane 1               | 12. signal connector on backplane 1              |
| 13. power connector on backplane 2               | 14. SAS B connector on backplane 2               |
| 15. SAS A connector on backplane 2               | 16. signal connector on backplane 2              |

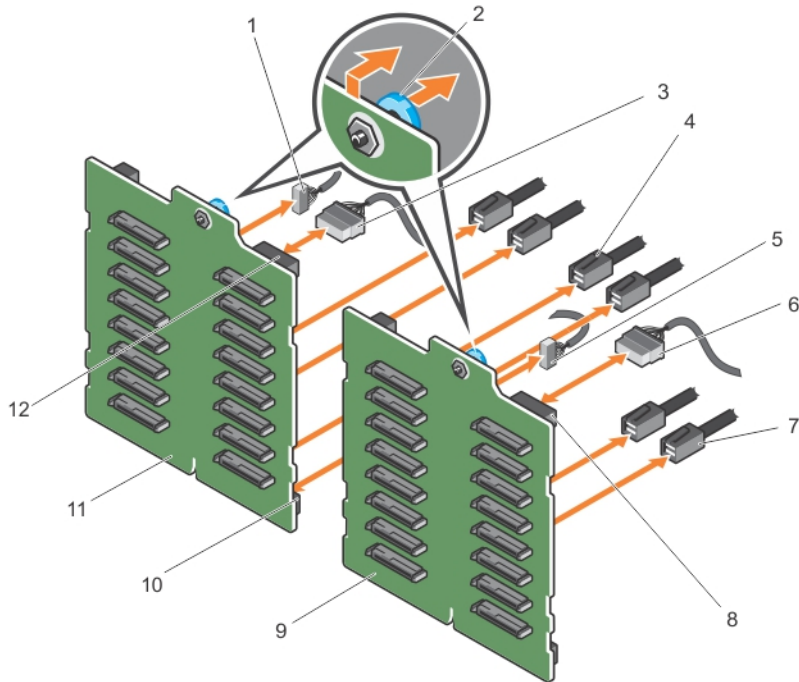

**Figure 59. Removing and installing 2.5 inch (x32) SAS/SATA backplane with a single PERC card**

- |                                |                                    |
|--------------------------------|------------------------------------|
| 1. signal cable to backplane 2 | 2. release pin                     |
| 3. power cable to backplane 2  | 4. SAS cable to backplane 2        |
| 5. signal cable to backplane 1 | 6. power cable to backplane 1      |
| 7. SAS cable to backplane 1    | 8. power connector on backplane 1  |
| 9. x16 backplane 1             | 10. SAS connector on backplane 2   |
| 11. x16 backplane 2            | 12. power connector on backplane 2 |

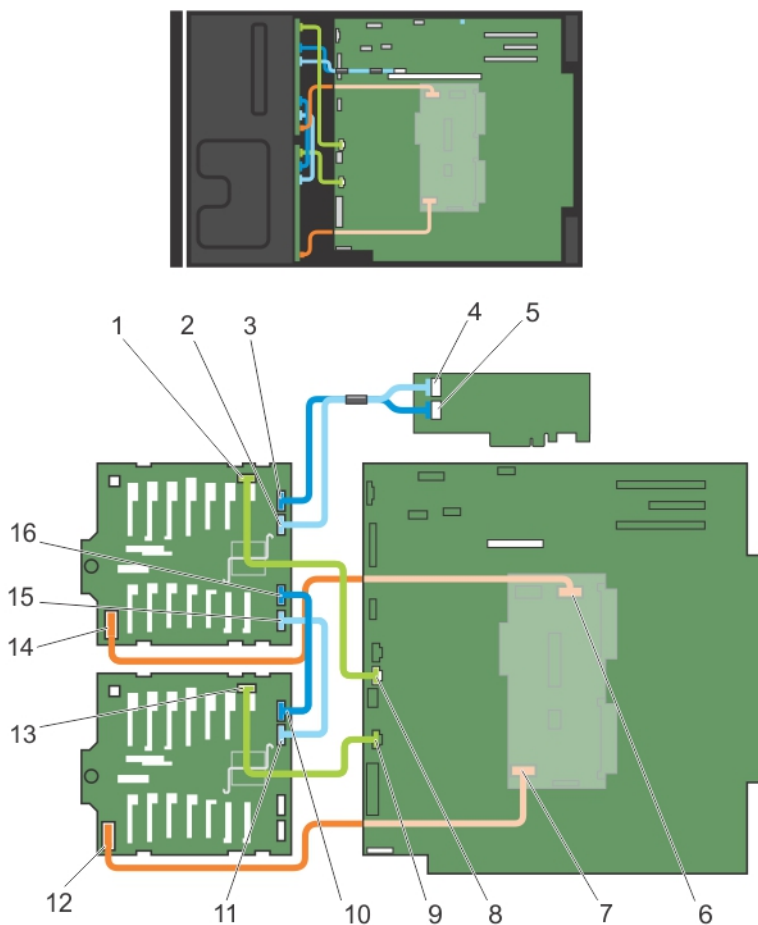

**Figure 60. Cabling—2.5 inch (x32) SAS/SATA backplane with a single PERC card**

- |   |   |
|---|---|
| 1. signal connector on backplane 2              | 2. SAS B connector on backplane 2               |
| 3. SAS A connector on backplane 2               | 4. SAS B connector on PERC                      |
| 5. SAS A connector on PERC                      | 6. backplane 2 power connector on PDB           |
| 7. backplane 1 power connector on PDB           | 8. backplane 2 signal connector on system board |
| 9. backplane 1 signal connector on system board | 10. SAS A connector on backplane 1              |
| 11. SAS B connector on backplane 1              | 12. power connector on backplane 1              |
| 13. signal connector on backplane 1             | 14. power connector on backplane 2              |
| 15. SAS B1 connector on backplane 2             | 16. SAS A1 connector on backplane 2             |

## Installing the hard-drive backplane

### Prerequisites

 **CAUTION:** Many repairs may only be done by a certified service technician. You should only perform troubleshooting and simple repairs as authorized in your product documentation, or as directed by the online or telephone service and support team. Damage due to servicing that is not authorized by Dell is not covered by your warranty. Read and follow the safety instructions that came with the product.

1. Ensure that you read the [Safety instructions](#).
2. Follow the procedure listed in [Before working inside your system](#).
3. Remove all the hard drives. For more information, see [Removing a hot-swap hard drive](#)
4. If applicable, remove the cooling-fan assembly. For more information, see [Removing the cooling-fan assembly \(optional\)](#)
5. Remove the cooling shroud. For more information, see [Removing the cooling shroud](#).

### Steps

1. Use the hooks at the base of the chassis as guides to align the hard-drive backplane.
2. Lower the hard-drive backplane into the chassis to secure the hard-drive backplane into place.
  -  **NOTE:** For a Dell PowerEdge Express Flash (PCIe SSD) backplane, lower the hard-drive backplane into the chassis until the release tab snaps into place.
3. Connect the SAS/SATA/SSD data, signal, and power cable(s) to the backplane. See the cabling instructions provided in this document.

### Next steps

1. If applicable, install the cooling-fan assembly. For more information, see [Installing the cooling-fan assembly \(optional\)](#).
2. Install the cooling shroud. For more information, see [Installing the cooling shroud](#).
3. Install the hard drives in their original locations.
4. Follow the procedure listed in [After working inside your system](#).

## SD vFlash media card

A vFlash SD card is a Secure Digital (SD) card that plugs into the vFlash SD card slot in the system. It provides persistent on-demand local storage and a custom deployment environment that allows automation of server configuration, scripts, and imaging. It emulates USB device(s). For more information, see the Integrated Dell Remote Access Controller User's Guide at [dell.com/esmanuals](http://dell.com/esmanuals).

### Replacing an SD vFlash media card

1. Locate the SD vFlash media slot on the system.
2. To remove the SD vFlash media card, push the card inward to release it, and pull the card from the card slot.

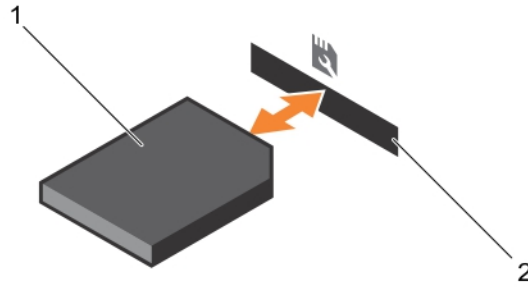

**Figure 61. Removing and installing the SD vFlash media card**

1. SD vFlash media card
  2. SD vFlash media-card slot
  3. To install an SD vFlash media card, with the label side facing up, insert the contact-pin end of the SD vFlash media card into the card slot on the module.
-  **NOTE:** The slot is keyed to ensure correct insertion of the card.
4. Press the card inward to lock it into the slot.

## Control panel assembly

### Removing the control panel assembly

#### Prerequisites

1. Ensure that you read the [Safety instructions](#).
2. Keep the #2 Phillips screwdriver ready.
3. Follow the procedure listed in [Before working inside your system](#).
4. If applicable, remove the cooling fan assembly.

 **CAUTION:** Many repairs may only be done by a certified service technician. You should only perform troubleshooting and simple repairs as authorized in your product documentation, or as directed by the online or telephone service and support team. Damage due to servicing that is not authorized by Dell is not covered by your warranty. Read and follow the safety instructions that came with the product.

#### Steps

1. Remove the screw securing the control panel to the chassis.
2. Disconnect the control panel cable and the control panel USB cable from the system board.

 **CAUTION:** Do not use excessive force when removing the control panel cables as it can damage the connectors.

3. Slide the control panel out of the chassis.
4. Disconnect the cables from the control panel.

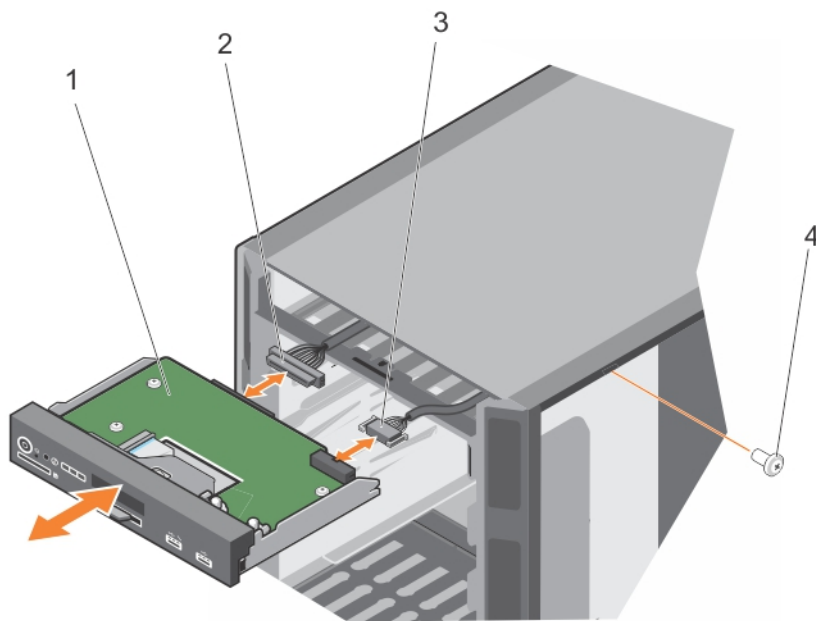

**Figure 62. Removing and installing the control panel assembly**

- |                            |                        |
|----------------------------|------------------------|
| 1. control panel           | 2. control panel cable |
| 3. control panel USB cable | 4. screw               |

 **NOTE:** Follow the same steps to remove the control panel in the rack-mode configuration.

5. Locate and press the tabs on the information tag.
6. Push the information tag out of the slot to remove it from the control panel.

 **NOTE:** Retain the information tag to replace it in the new control panel.

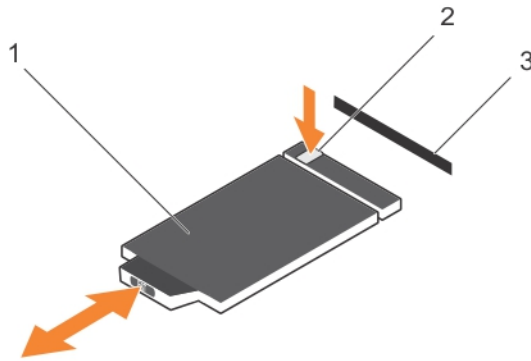

**Figure 63. Removing and installing the information tag**

1. information tag
2. tab
3. slot

## Installing the control panel assembly

### Prerequisites

**⚠ CAUTION:** Many repairs may only be done by a certified service technician. You should only perform troubleshooting and simple repairs as authorized in your product documentation, or as directed by the online or telephone service and support team. Damage due to servicing that is not authorized by Dell is not covered by your warranty. Read and follow the safety instructions that came with the product.

1. Ensure that you read the [Safety instructions](#).
2. Keep the #2 Phillips screwdriver ready.

### Steps

1. Replace the blank information tag in the new control panel with the information tag retained from the old control panel.

**📎 NOTE:** Information tag lists system information such as Service Tag, NIC, MAC address, and so on.

2. To install the information tag, push the information tag into the control-panel slot.
3. Connect the control panel cable and the control panel USB cable to the control panel module.
4. Align and insert the control panel into the control panel slot in the chassis.
5. Secure the control panel to the chassis using the screw.
6. Connect the control panel cable and the control panel USB cable to the system board.

### Next steps

1. If applicable, install the cooling fan assembly.
2. Follow the procedure listed in [After working inside your system](#).







# System board

The system board has the connectors for your system components and also contains the integrated components.

## Removing the system board

### Prerequisites

-  **CAUTION:** Many repairs may only be done by a certified service technician. You should only perform troubleshooting and simple repairs as authorized in your product documentation, or as directed by the online or telephone service and support team. Damage due to servicing that is not authorized by Dell is not covered by your warranty. Read and follow the safety instructions that came with the product.
-  **CAUTION:** If you are using the Trusted Platform Module (TPM) with an encryption key, you may be prompted to create a recovery key during program or System Setup. Be sure to create and safely store this recovery key. If you replace this system board, you must supply the recovery key when you restart your system or program before you can access the encrypted data on your hard drives.
-  **CAUTION:** Do not attempt to remove the TPM plug-in module from the motherboard. Once the TPM plug-in module is installed, it is cryptographically bound to that specific motherboard. Any attempt to remove an installed TPM plug-in module breaks the cryptographic binding, and it cannot be re-installed or installed on another motherboard.

1. Ensure that you read the [Safety instructions](#).
2. Keep the #2 Phillips screwdriver ready.
3. Follow the procedure listed in [Before working inside your system](#).
4. Remove the following:
  - a. PCIe card holder
  - b. cooling shroud
  - c. cooling-fan assembly, if applicable
  - d. integrated storage controller card
  - e. internal dual SD module
  - f. internal USB key (if installed)
  - g. heat sink(s)
  - h. processors(s)
    -  **CAUTION:** To prevent damage to the processor pins when replacing a faulty system board, ensure that you cover the processor socket with the processor protective cap.
  - i. memory modules

### Steps

1. Disconnect all cables from the system board.
  -  **CAUTION:** Take care not to damage the system identification button while removing the system board from the chassis.
2. Hold the post, pull the blue release pin, and slide the system board toward the front of the system.
3. Holding the post, incline the system board at an angle, and lift the system board out of the chassis.

△ CAUTION: Do not lift the system board assembly by grasping a memory module, processor, or other components.

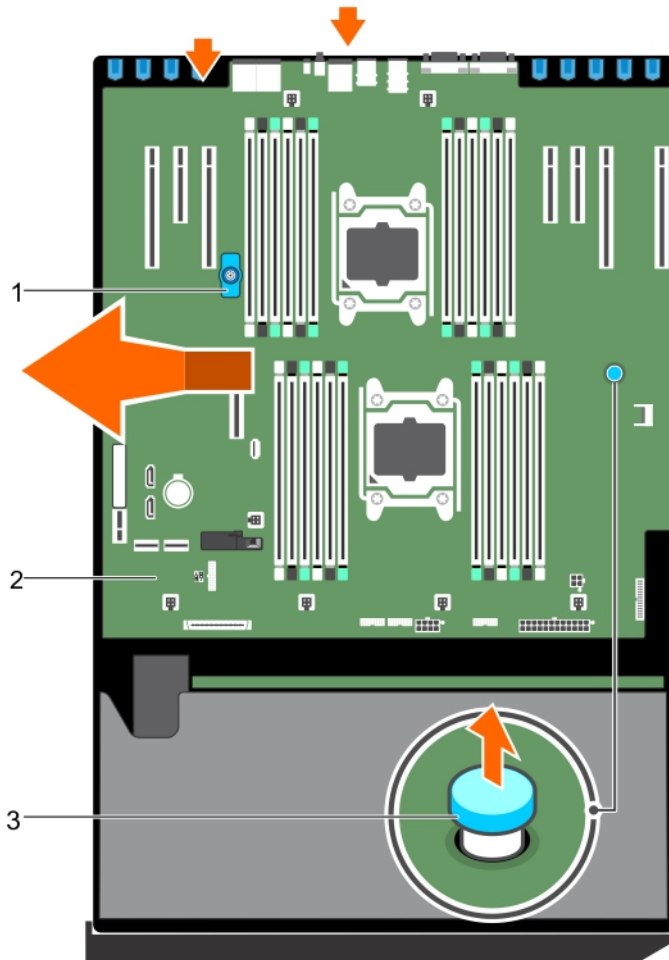

Figure 64. Removing the system board

- |                |                 |
|----------------|-----------------|
| 1. post        | 2. system board |
| 3. release pin |                 |

## Installing the system board

### Prerequisites

△ CAUTION: Many repairs may only be done by a certified service technician. You should only perform troubleshooting and simple repairs as authorized in your product documentation, or as directed by the online or telephone service and support team. Damage due to servicing that is not authorized by Dell is not covered by your warranty. Read and follow the safety instructions that came with the product.

1. Ensure that you read the [Safety instructions](#).
2. Keep the #2 Phillips screwdriver ready.
3. Follow the procedure listed in [Before working inside your system](#).

## Steps

1. Unpack the new system board assembly.



**CAUTION: Do not lift the system board assembly by grasping a memory module, processor, or other components.**

2. Hold the post, incline the system board, and lower the system board into the chassis.
3. Push the system board toward the back of the chassis such that the ports on the system board align with the corresponding slots on the chassis.

## Next steps

1. Install the Trusted Platform Module (TPM). For information on how to install TPM, see [Installing the Trusted Platform Module](#). For information on TPM, see [Trusted Platform Module](#).
2. Install the following:
  - a. processors(s) and heat sink(s)
  - b. internal USB key (if installed)
  - c. internal dual SD module
  - d. integrated storage controller card
  - e. cooling-fan assembly, if applicable
  - f. cooling shroud
  - g. PCIe card holder
3. Reconnect all cables to the system board.

 **NOTE:** Ensure that the cables inside the system are routed along the chassis wall and secured using the cable securing bracket.
4. Follow the procedure listed in [After working inside your system](#).
5. Import your new or existing iDRAC Enterprise license. For more information, see Integrated Dell Remote Access Controller User's Guide at [dell.com/esmanuals](http://dell.com/esmanuals).
6. Ensure that you:
  - a. Use the **Easy Restore** feature to restore the service tag. For more information, see [Easy Restore](#).
  - b. If the service tag is not backed up in the backup flash device, enter the system service tag manually. For more information, see [Entering the system service tag using System Setup](#).
  - c. Update the BIOS and iDRAC versions.
  - d. Re-enable the Trusted Platform Module (TPM). For more information, see [Re-enabling the TPM for BitLocker users](#) or [Re-enabling the TPM for Intel TXT users](#).

## Entering the system service tag using System Setup

If you know the system service tag, use the System Setup menu to enter the service tag.

1. Turn on the system.
2. Press <F2> to enter the System Setup.
3. Click **Service Tag Settings**.
4. Enter the service tag.



**NOTE:** You can enter the service tag only when the **Service Tag** field is empty. Ensure that you enter the correct service tag. Once the service tag is entered, it cannot be updated or changed.

5. Click **Ok**.

## Restoring the service tag using Easy Restore

Use the Easy Restore feature if you do not know the service tag of your system. The Easy Restore feature allows you to restore your system's service tag, license, UEFI configuration, and the system configuration

data after replacing the system board. All data is backed up in a backup flash device automatically. If BIOS detects a new system board and the service tag in the backup flash device, BIOS prompts the user to restore the backup information.

**1.** Turn on the system.

If BIOS detects a new system board, and if the service tag is present in the backup flash device, BIOS displays the service tag, the status of the license, and the **UEFI Diagnostics** version.

**2.** Do one of the following:

- Press **Y** to restore the service tag, license, and diagnostics information.
- Press **N** to navigate to the Lifecycle Controller based restore options.
- Press <F10> to restore data from a previously created **Hardware Server Profile**.

After the restore process is complete, BIOS prompts to restore the system configuration data.

**3.** Do one of the following:

- Press **Y** to restore the system configuration data.
- Press **N** to use the default configuration settings.

After the restore process is complete, the system reboots.

## Trusted Platform Module

The Trusted Platform Module (TPM) is used to generate/store keys, protect/authenticate passwords, and create/store digital certificates. TPM can also be used to enable the BitLocker hard drive encryption feature in Windows Server.

### Installing the Trusted Platform Module

#### Prerequisites

Ensure that you read the [Safety instructions](#).



**CAUTION: Do not remove an installed Trusted Platform Module (TPM). Any attempt to remove an installed TPM from the system board may damage the TPM.**

#### Steps

1. Align the edge connectors on the TPM with the slot on the TPM connector.
2. Insert the TPM into the TPM connector such that the plastic bolt aligns with the slot on the system board.
3. Press the plastic bolt until the bolt snaps into place.

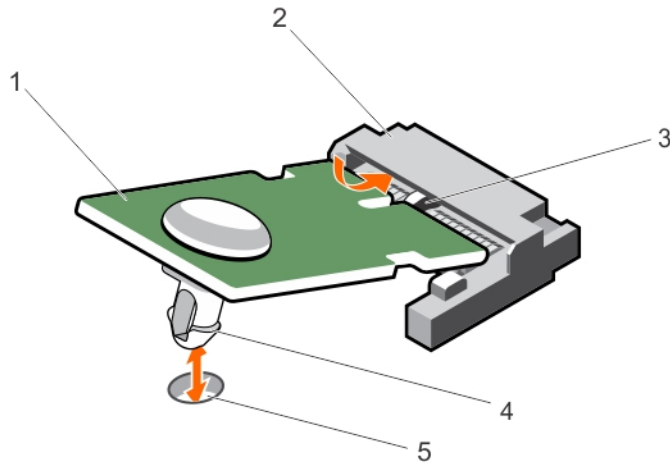

**Figure 65. Installing the TPM**

- |                              |                  |
|------------------------------|------------------|
| 1. TPM                       | 2. TPM connector |
| 3. slot on the TPM connector | 4. plastic bolt  |
| 5. slot on the system board  |                  |

## Re-enabling the TPM for BitLocker users

Initialize the TPM.

For more information on initializing the TPM, see <http://technet.microsoft.com/en-us/library/cc753140.aspx>.

The **TPM Status** changes to **Enabled, Activated**.

## Re-enabling the TPM for TXT users

1. While booting your system, press <F2> to enter System Setup.
2. In the **System Setup Main Menu**, click **System BIOS** → **System Security Settings**.
3. In the **TPM Security** option, select **On with Pre-boot Measurements**.
4. In the **TPM Command** option, select **Activate**.
5. Save the settings.
6. Reboot your system.
7. Enter System Setup again.
8. In the **System Setup Main Menu**, click **System BIOS** → **System Security Settings**.
9. In the **Intel TXT** option, select **On**.

# Power interposer board and power distribution board

## Removing the power interposer board

### Prerequisites

 **CAUTION:** Many repairs may only be done by a certified service technician. You should only perform troubleshooting and simple repairs as authorized in your product documentation, or as directed by the online or telephone service and support team. Damage due to servicing that is not authorized by Dell is not covered by your warranty. Read and follow the safety instructions that came with the product.

1. Ensure that you read the [Safety instructions](#).
2. Follow the procedure listed in [Before working inside your system](#).

 **CAUTION:** To prevent damage to the power interposer board (PIB), you must remove the power supply module(s) from the system before removing the power interposer board or power distribution board (PDB).

3. Remove the power supply module(s) from the back of the chassis.
4. Remove the PCIe card holders.
5. Remove the cooling shroud.
6. If applicable, remove the cooling fan assembly.
7. Disconnect the power cables to the system board and the hard-drive backplane.
8. Remove the system board. For more information, see [Removing the system board](#).

### Steps

1. Pull the release pin and detach the PIB from the PDB.
2. Slide and lift the PIB up until the grooves on the PIB disengage from the pins on the chassis.

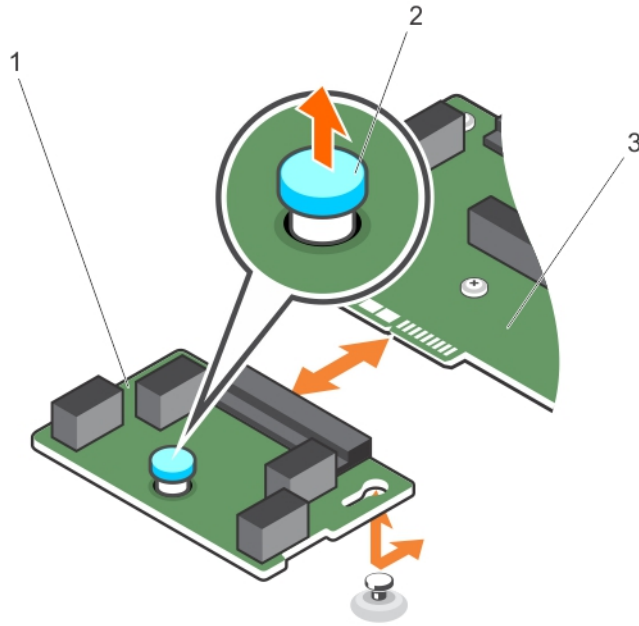

**Figure 66. Removing and installing the power interposer board**

- |  |  |
|--|--|
| <ol style="list-style-type: none"> <li>1. power interposer board</li> <li>3. power distribution board</li> </ol> | <ol style="list-style-type: none"> <li>2. release pin</li> </ol> |
|--|--|

## Removing the power distribution board

### Prerequisites

**CAUTION:** Many repairs may only be done by a certified service technician. You should only perform troubleshooting and simple repairs as authorized in your product documentation, or as directed by the online or telephone service and support team. Damage due to servicing that is not authorized by Dell is not covered by your warranty. Read and follow the safety instructions that came with the product.

1. Ensure that you read the [Safety instructions](#).
2. Keep the #2 Phillips screwdriver ready.
3. Follow the procedure listed in [Before working inside your system](#).

**CAUTION:** To prevent damage to the power interposer board (PIB), you must remove the power supply module(s) from the system before removing the power interposer board or power distribution board (PDB).

4. Remove the power supply module(s) from the back of the chassis.
5. Remove the PCIe card holders.
6. Remove the cooling shroud.
7. If applicable, remove the cooling fan assembly.
8. Disconnect the power cables to the system board and the hard-drive backplane.
9. Remove the system board. For more information, see [Removing the system board](#).
10. Remove the power interposer board.

### Steps

1. Disconnect the power cables from the power distribution board (PDB).
2. Remove the six screws securing the PDB to the chassis.
3. Lift the PDB up and out of the chassis.

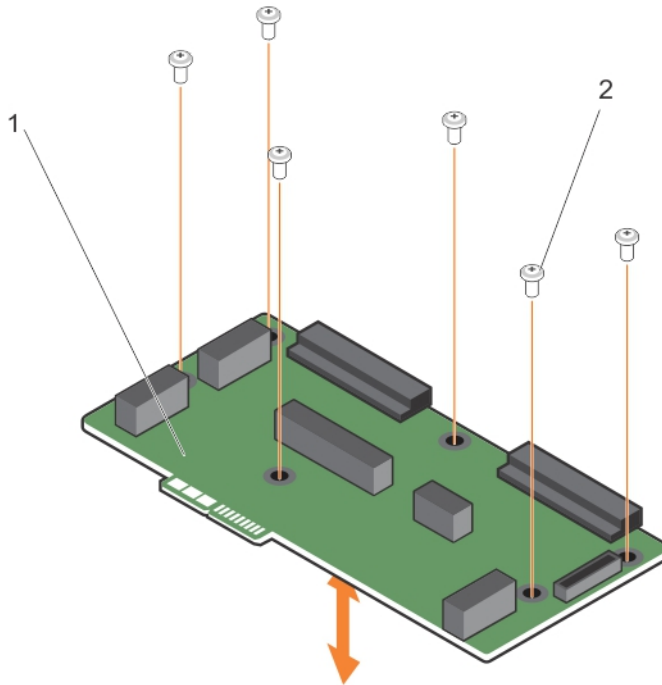

Figure 67. Removing and installing the power distribution board

1. power distribution board
2. screws (6)

## Installing the power distribution board

### Prerequisites

**CAUTION:** Many repairs may only be done by a certified service technician. You should only perform troubleshooting and simple repairs as authorized in your product documentation, or as directed by the online or telephone service and support team. Damage due to servicing that is not authorized by Dell is not covered by your warranty. Read and follow the safety instructions that came with the product.

1. Ensure that you read the [Safety instructions](#).
2. Keep the #2 Phillips screwdriver ready.

### Steps

1. Align the screw holes on the power distribution board (PDB) with the holes on the chassis.
2. Secure the PDB on to the chassis using the six screws.
3. Connect the power cables to the PDB.

### Next steps

1. Install the power interposer board.



2. Install the system board. For more information, see [Installing the system board](#).
3. Connect the power cables to the system board and the hard-drive backplane.
4. If applicable, install the cooling fan assembly.
5. Install the cooling shroud.
6. Install the PCIe card holders.
7. Install the power supply module(s) in their original locations.
8. Follow the procedure listed in [After working inside your system](#).

## Installing the power interposer board

### Prerequisites

 **CAUTION:** Many repairs may only be done by a certified service technician. You should only perform troubleshooting and simple repairs as authorized in your product documentation, or as directed by the online or telephone service and support team. Damage due to servicing that is not authorized by Dell is not covered by your warranty. Read and follow the safety instructions that came with the product.

Ensure that you read the [Safety instructions](#).

### Steps

1. Install the power distribution board (PDB).
2. Align the power interposer board (PIB) connector with the connector on the PDB.
3. Keeping the grooves on the PIB aligned with the pins on the chassis, connect the PIB to the connector on the PDB.

### Next steps

1. Install the system board. For more information, see [Installing the system board](#).
2. Connect the power cables to the system board and the hard-drive backplane.
3. If applicable, install the cooling fan assembly.
4. Install the cooling shroud.
5. Install the PCIe card holders.
6. Install the power supply module(s) in their original locations.
7. Follow the procedure listed in [After working inside your system](#).

## System top cover

Do not remove the system top cover unless you are converting the system from tower to rack mode.

## Removing the system top cover

### Prerequisites

 **CAUTION:** Many repairs may only be done by a certified service technician. You should only perform troubleshooting and simple repairs as authorized in your product documentation, or as directed by the online or telephone service and support team. Damage due to servicing that is not authorized by Dell is not covered by your warranty. Read and follow the safety instructions that came with the product.

1. Ensure that you read the [Safety instructions](#).
2. Keep the #2 Phillips screwdriver ready.

3. Turn off the system, including any attached peripherals, and disconnect the system from the electrical outlet and peripherals.
4. Remove the system cover.

#### Steps

1. Remove the screws that secure the top cover to the chassis.
2. Slide the cover toward the front of the system and lift it from the system.

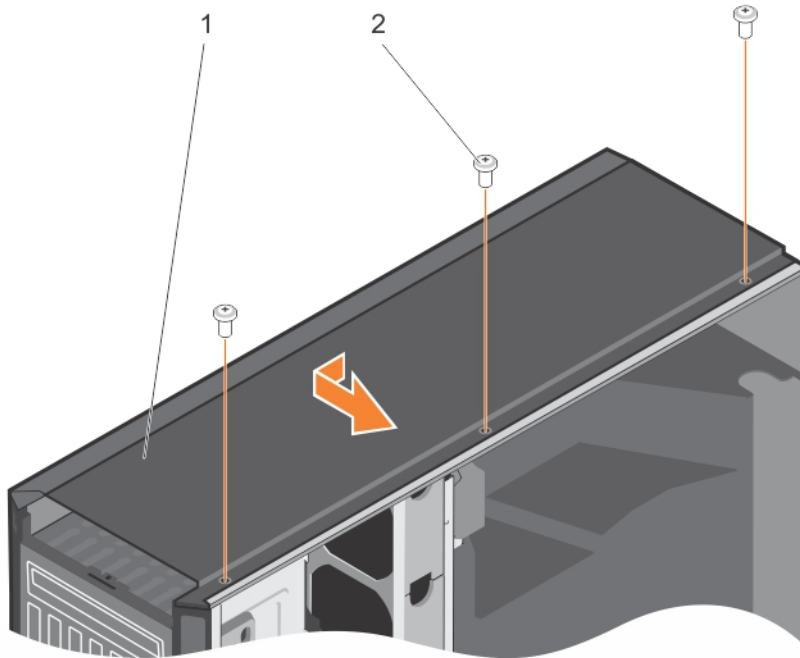

Figure 68. Removing the installing the system top cover

1. system top cover

2. screws (3)

## Installing the system top cover

#### Prerequisites

**⚠ CAUTION:** Many repairs may only be done by a certified service technician. You should only perform troubleshooting and simple repairs as authorized in your product documentation, or as directed by the online or telephone service and support team. Damage due to servicing that is not authorized by Dell is not covered by your warranty. Read and follow the safety instructions that came with the product.

1. Ensure that you read the [Safety instructions](#).
2. Keep the #2 Phillips screwdriver ready.

#### Steps

1. Align the tabs on the top cover with the notches inside the system left side cover.
2. Insert the tabs on the top cover inside the system left cover.
3. Slide the cover toward the back of the system until the screw holes on the cover aligns with the slots on the chassis.

4. Secure the cover onto the chassis using the screws.

**Next steps**

1. Close the system.
2. Reconnect the system to its electrical outlet and turn the system on, including any attached peripherals.

# Converting the system from tower mode to rack mode

Your system can be converted from the tower mode to the rack mode.

To convert your system from the tower mode to the rack mode, you require the tower to rack conversion kit, which contains the following items:

- Rack ears (left and right) with three screws each
- VGA module
- Rack slide cover
- Mylar cover
- A pair of rails (optional)

## Safety instructions

 **CAUTION:** Many repairs may only be done by a certified service technician. You should only perform troubleshooting and simple repairs as authorized in your product documentation, or as directed by the online or telephone service and support team. Damage due to servicing that is not authorized by Dell is not covered by your warranty. Read and follow the safety instructions that came with the product.

 **CAUTION:** Do not attempt to convert your system into a rack unless authorized by Dell. Only customers certified by Dell for tower to rack conversion can convert a tower system into a rack system.

 **NOTE:** For specific caution statements and procedures, see the rack installation documentation for your system at [dell.com/poweredge manuals](http://dell.com/poweredge manuals). For complete safety and regulatory information, see the safety instructions that shipped with your system.

Observe the following precautions for stability and safety of the system in rack mode:

- Before installing your equipment in a rack, install the front and side rack stabilizers. Failure to install stabilizers can allow the rack to tip over.
- Always load from the bottom up, and load the heaviest items first.
- Do not overload the AC power supply branch circuit that provides power to the rack.

## Preparing a system for conversion from tower mode to rack mode

### Prerequisites

1. Ensure that you read the [Safety instructions](#).
2. Keep the #2 Phillips screwdriver ready.

3. Turn off the system, including any attached peripherals, and disconnect the system from the electrical outlet and peripherals.
4. Lay the system on a flat, stable surface.
5. If installed, remove the system feet or caster wheels. For more information, see [Removing the system feet](#) or [Removing caster wheels](#).
6. Remove the system cover.

### Steps

1. Remove the system top cover. For more information, see [Removing the system top cover](#).
2. Remove the control-panel assembly. For more information, see [Removing the control panel assembly](#).
3. Install the rack slide cover by performing the following steps:
  - a. Slide the rack slide cover between the system's side cover and the chassis.
  - b. Slide the rack slide cover toward the back of the system until the tabs on rack slide cover locks with the tabs extending from the chassis.

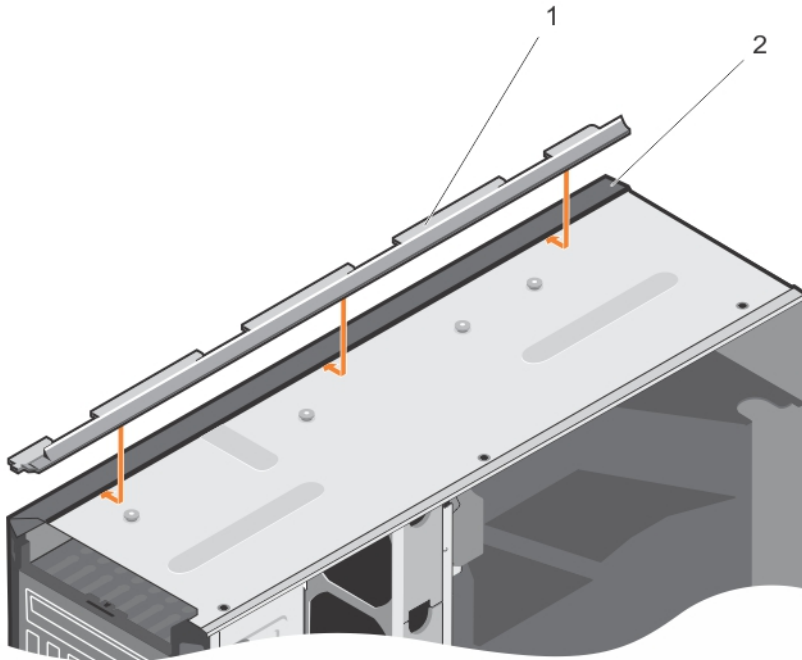

**Figure 69. Removing and installing the rack slide cover**

1. rack slide cover
2. system chassis
4. Install the control panel assembly. For more information, see [Installing the control panel assembly](#).
5. Attach the mylar to cover the openings on the chassis where the system rear feet were installed in the tower mode. See the following figure for more information.

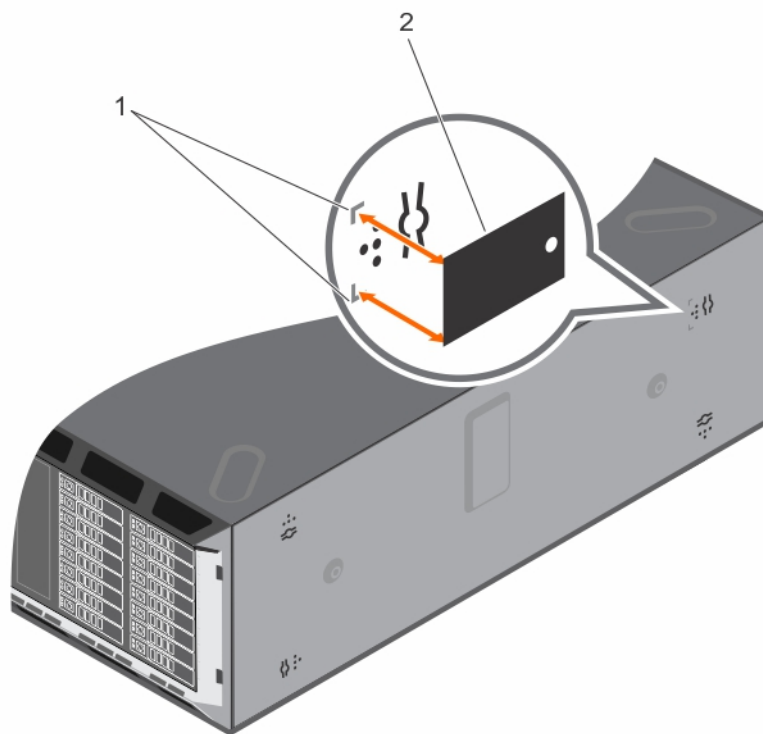

**Figure 70. Attaching the mylar cover**

1. marking on chassis
  2. mylar cover
6. Install the system cover.
  7. Install the rack ears by performing the following steps:
    - a. Align the three screw holes on the rack ears with the screw holes on the top and the bottom of system.
    - b. Install the three screws using a #2 Phillips screwdriver.

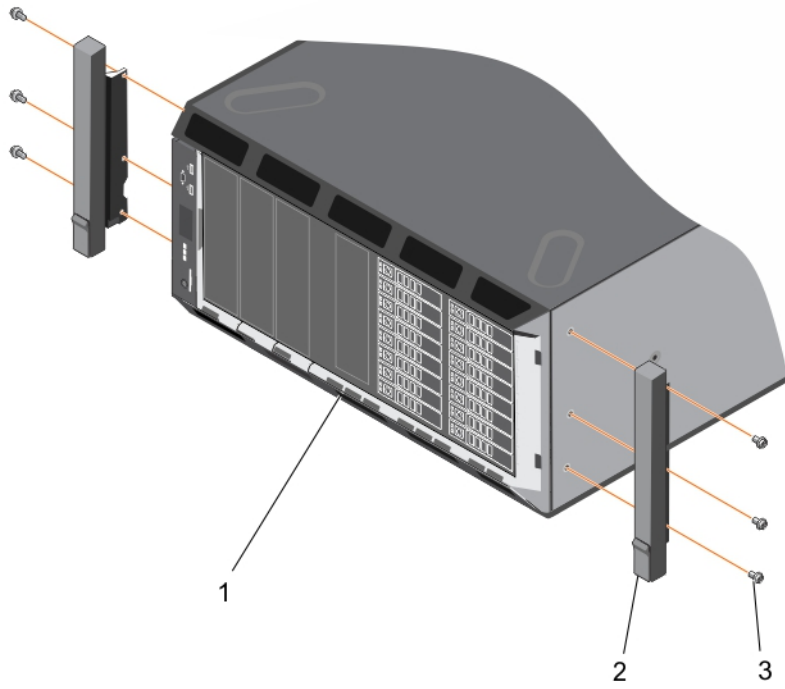

**Figure 71. Removing and installing the rack ears**

1. system in rack mode
  2. rack ear (2)
  3. screw (6)
- 8.** Install the system in the rack. For more information, see the system's Rack Installation Guide.

# Troubleshooting your system

## Safety first—for you and your system

 **CAUTION:** Many repairs may only be done by a certified service technician. You should only perform troubleshooting and simple repairs as authorized in your product documentation, or as directed by the online or telephone service and support team. Damage due to servicing that is not authorized by Dell is not covered by your warranty. Read and follow the safety instructions that came with the product.

## Troubleshooting system startup failure

If you boot the system to the BIOS boot mode after installing an operating system from the UEFI Boot Manager, the system hangs. The reverse is also true. You must boot to the same boot mode in which you installed the operating system.

For all other startup issues, note the system messages that appear on the screen.

## Troubleshooting external connections

Ensure that all external cables are securely attached to the external connectors on your system before troubleshooting any external devices.

## Troubleshooting the video subsystem

1. Check the system and power connections to the monitor.
2. Check the video interface cabling from the system to the monitor.
3. Run the appropriate diagnostic test.

If the tests run successfully, the problem is not related to video hardware.

If the tests fail, see [Getting Help](#).

## Troubleshooting a USB device

### About this task

Use the following steps to troubleshoot a USB keyboard/mouse. For other USB devices, go to step 7.

### Steps

1. Disconnect the keyboard and mouse cables from the system and reconnect them.
2. If the problem persists, connect the keyboard/mouse to the USB port(s) on the opposite side of the system.



3. If the problem is resolved, restart the system, enter the System Setup, and check if the non-functioning USB ports are enabled.  
Check if USB 3.0 is enabled in System Setup. If enabled, disable it and see if the issue is resolved (older operating systems may not support USB 3.0).
4. In the **IDRAC Settings Utility**, ensure the **USB Management Port Mode** is configured as **Automatic or Standard OS Use**.
5. Replace the keyboard/mouse with a working keyboard/mouse.  
If the problem is not resolved, proceed to the next step to begin troubleshooting other USB devices attached to the system.
6. Power down all attached USB devices and disconnect them from the system.
7. Reboot the system and, if your keyboard is functioning, enter the System Setup.
8. Verify that all USB ports are enabled on the **Integrated Devices** screen, in the System Setup options.
9. Check if USB 3.0 is enabled in System Setup. If it is enabled, disable it and restart your system.  
If your keyboard is not functioning, you can also use remote access.
10. If the system is not accessible, reset the NVRAM\_CLR jumper inside your system and restore the BIOS to the default settings.
11. In the **IDRAC Settings Utility**, ensure the **USB Management Port Mode** is configured as **Automatic or Standard OS Use**.
12. Reconnect and power on each USB device one at a time.
13. If a USB device causes the same problem, power down the device, replace the USB cable with a known good cable, and power up the device.

#### Next steps

If all troubleshooting fails, see [Getting Help](#).

## Troubleshooting iDRAC Direct (USB XML configuration)

For information on USB storage device and server configuration, see the Integrated Dell Remote Access Controller User's Guide at [dell.com/esmanuals](http://dell.com/esmanuals).

#### Steps

1. Ensure your USB storage device is connect to the front USB Management Port, identified by  icon.
2. Ensure your USB storage device is configured with an NTFS or a FAT32 file system with only one partition.
3. Verify that the USB storage device is configured correctly. For more information on configuring the USB storage device, see the Integrated Dell Remote Access Controller User's Guide at [dell.com/esmanuals](http://dell.com/esmanuals).
4. In the **IDRAC Settings Utility**, ensure the **USB Management Port Mode** is configured as **Automatic or iDRAC Direct Only**.
5. Make sure the **iDRAC Managed: USB XML Configuration** option is either **Enabled** or **Enabled only when the server has default credential settings**.
6. Remove and re-insert the USB storage device.
7. If import operation does not work, try with a different USB storage device.

#### Next steps

If all troubleshooting fails, see [Getting help](#).

## Troubleshooting iDRAC Direct (laptop connection)

For information on USB laptop connection and server configuration, see the Integrated Dell Remote Access Controller User's Guide at [dell.com/esmanuals](http://dell.com/esmanuals).

### Steps

1. Make sure your laptop is connected to the front USB Management Port, identified by  icon with a USB Type A/A cable.
2. In the **iDRAC Settings Utility**, ensure the **USB Management Port Mode** is configured as **Automatic or iDRAC Direct Only**.
3. If the laptop is running the Windows operating system, ensure the iDRAC Virtual USB NIC device driver is installed.
4. If the driver is installed, ensure you are not connected to any network through WiFi or cabled ethernet as iDRAC Direct uses a non-routable address.

### Next steps

If all troubleshooting fails, see [Getting help](#).

## Troubleshooting a serial I/O device

### Steps

1. Turn off the system and any peripheral devices connected to the serial port.
2. Swap the serial interface cable with a working cable, and turn on the system and the serial device.  
If the problem is resolved, replace the interface cable with a known good cable.
3. Turn off the system and the serial device, and swap the serial device with a comparable device.
4. Turn on the system and the serial device.

### Next steps

If the problem persists, see [Getting Help](#).

## Troubleshooting a NIC

### Steps

1. Run the appropriate diagnostic test. See [Using System Diagnostics](#) for available diagnostic tests.
2. Reboot the system and check for any system messages pertaining to the NIC controller.
3. Check the appropriate indicator on the NIC connector:
  - If the link indicator does not light, check all cable connections.
  - If the activity indicator does not light, the network driver files might be damaged or missing. Remove and reinstall the drivers if applicable. See the NIC documentation.
  - If applicable, change the autonegotiation setting.
  - Use another connector on the switch or hub.
4. Ensure that the appropriate drivers are installed and the protocols are bound. See the NIC documentation.
5. Enter the System Setup and confirm that the NIC ports are enabled on the **Integrated Devices** screen.
6. Ensure that the NICs, hubs, and switches on the network are all set to the same data transmission speed and duplex. See the documentation for each network device.

7. Ensure that all network cables are of the proper type and do not exceed the maximum length.

#### Next steps

If all troubleshooting fails, see [Getting Help](#).

## Troubleshooting a wet system

#### Prerequisites



**CAUTION:** Many repairs may only be done by a certified service technician. You should only perform troubleshooting and simple repairs as authorized in your product documentation, or as directed by the online or telephone service and support team. Damage due to servicing that is not authorized by Dell is not covered by your warranty. Read and follow the safety instructions that came with the product.

#### Steps

1. Turn off the system and attached peripherals, and disconnect the system from the electrical outlet.
2. Remove the system cover.
3. Remove the following components from the system:
  - hard drives
  - hard-drive backplane
  - USB memory key
  - hard-drive tray
  - cooling shroud
  - expansion-card risers (if present)
  - expansion cards
  - power supply unit(s)
  - cooling-fan assembly (if present)
  - cooling fans
  - processor(s) and heat sink(s)
  - memory modules
4. Let the system dry thoroughly for at least 24 hours.
5. Reinstall the components you removed in step 3.
6. Install the system cover.
7. Turn on the system and attached peripherals.  
If the system does not start properly, see [Getting Help](#).
8. If the system starts properly, shut down the system, and reinstall all the expansion cards that you removed.
9. Run the appropriate diagnostic test. For more information, see [Using System Diagnostics](#).

#### Next steps

If the tests fail, see [Getting Help](#).

# Troubleshooting a damaged system

## Prerequisites

 **CAUTION:** Many repairs may only be done by a certified service technician. You should only perform troubleshooting and simple repairs as authorized in your product documentation, or as directed by the online or telephone service and support team. Damage due to servicing that is not authorized by Dell is not covered by your warranty. Read and follow the safety instructions that came with the product.

## Steps

1. Turn off the system and attached peripherals, and disconnect the system from the electrical outlet.
2. Remove the system cover.
3. Ensure that the following components are properly installed:
  - Cooling shroud
  - Expansion-card risers (if present)
  - Expansion cards
  - Power supply(s)
  - Cooling-fan assembly (if present)
  - Cooling fans
  - Processor(s) and heat sink(s)
  - Memory modules
  - Hard-drive carriers
  - Hard-drive backplane
4. Ensure that all cables are properly connected.
5. Install the system cover.
6. Run the appropriate diagnostic test. For more information, see [Using System Diagnostics](#).

## Next steps

If the tests fail, see [Getting Help](#).

# Troubleshooting the system battery

## Prerequisites

 **CAUTION:** Many repairs may only be done by a certified service technician. You should only perform troubleshooting and simple repairs as authorized in your product documentation, or as directed by the online or telephone service and support team. Damage due to servicing that is not authorized by Dell is not covered by your warranty. Read and follow the safety instructions that came with the product.

 **NOTE:** If the system is turned off for long periods of time (for weeks or months), the NVRAM may lose its system configuration information. This situation is caused by a defective battery.

 **NOTE:** Some software may cause the system time to speed up or slow down. If the system seems to operate normally except for the time kept in the System Setup, the problem may be caused by software rather than by a defective battery.

### Steps

1. Re-enter the time and date in the System Setup.
2. Turn off the system and disconnect it from the electrical outlet for at least one hour.
3. Reconnect the system to the electrical outlet and turn on the system.
4. Enter the System Setup.  
If the date and time are not correct in the System Setup, check the SEL for system battery messages.

### Next steps

If the problem persists, see [Getting Help](#).

## Troubleshooting power supply units

 **CAUTION:** Many repairs may only be done by a certified service technician. You should only perform troubleshooting and simple repairs as authorized in your product documentation, or as directed by the online or telephone service and support team. Damage due to servicing that is not authorized by Dell is not covered by your warranty. Read and follow the safety instructions that came with the product.

### Power source problems

1. Press the power button to ensure that your system is turned on. If the power indicator does not light up when the power button is pressed, press the power-on button firmly.
2. Plug in another working device to ensure that the system board is not faulty.
3. Ensure that no loose connections exist.  
For example, loose power cables.
4. Ensure that the power source meets applicable standards.
5. Ensure that there are no short circuits.
6. Have a qualified electrician check the line voltage to ensure that it meets the required specifications.

### Power supply unit problems

1. Ensure that no loose connections exist.  
For example, loose power cables.
2. Ensure that the power supply handle/LED indicates that the power supply is working properly.  
For more information on power supply indicators, see [Power indicator codes](#).
3. If you have recently upgraded your system, ensure that the power supply unit has enough power to support the new system.
4. If you have a redundant power supply configuration, ensure that both the power supply units are of the same type and wattage.  
If the LED You may have to upgrade to a higher wattage power supply unit.
5. Ensure that you use only power supply units with the Extended Power Performance (EPP) label on the back.
6. Reseat the power supply unit.

 **NOTE:** After installing a power supply unit, allow several seconds for the system to recognize the power supply unit and determine if it is working properly.

If the problem persists, see [Getting Help](#).

## Troubleshooting cooling problems

 **CAUTION:** Many repairs may only be done by a certified service technician. You should only perform troubleshooting and simple repairs as authorized in your product documentation, or as directed by the online or telephone service and support team. Damage due to servicing that is not authorized by Dell is not covered by your warranty. Read and follow the safety instructions that came with the product.

Ensure that the following conditions exist:

- System cover, cooling shroud, EMI filler panel, or back-filler bracket is not removed.
- Ambient temperature is not too high.
- External airflow is not obstructed.
- A cooling fan is not removed or has not failed.
- The expansion card installation guidelines have been followed.

Additional cooling can be added by one of the following methods:

From the iDRAC Web GUI:

1. Click **Hardware** → **Fans** → **Setup**.
2. From the **Fan Speed Offset** drop-down list, select the cooling level needed or set the minimum fan speed to a custom value.

From F2 System Setup

1. Select **iDRAC Settings** → **Thermal**, and set a higher fan speed from the fan speed offset or minimum fan speed.

From RACADM commands

1. Run the command `racadm help system.thermalsettings`

For more information, see the Integrated Dell Remote Access Controller User's Guide at [dell.com/esmmanuals](http://dell.com/esmmanuals).

## Troubleshooting cooling fans

### Prerequisites

 **CAUTION:** Many repairs may only be done by a certified service technician. You should only perform troubleshooting and simple repairs as authorized in your product documentation, or as directed by the online or telephone service and support team. Damage due to servicing that is not authorized by Dell is not covered by your warranty. Read and follow the safety instructions that came with the product.

 **NOTE:** In the event of a problem with a particular fan, the fan number is referenced by the system's management software, allowing you to easily identify and replace the proper fan by noting the fan numbers on the cooling fan assembly.

### Steps

1. Remove the system cover.
2. Reseat the fan or the fan's power cable.

3. If the fan functions properly, install the system cover.

#### Next steps

If the problem persists, see [Getting Help](#).

## Troubleshooting system memory

#### Prerequisites



**CAUTION:** Many repairs may only be done by a certified service technician. You should only perform troubleshooting and simple repairs as authorized in your product documentation, or as directed by the online or telephone service and support team. Damage due to servicing that is not authorized by Dell is not covered by your warranty. Read and follow the safety instructions that came with the product.

#### Steps

1. If the system is operational, run the appropriate diagnostic test. See [Using system diagnostics](#) for available diagnostic tests.  
If diagnostics indicate a fault, follow the corrective actions provided by the diagnostic program.
2. If the system is not operational, turn off the system and attached peripherals, and unplug the system from the power source. Wait at least 10 seconds and then reconnect the system to the power source.
3. Turn on the system and attached peripherals and note the messages on the screen.  
If an error message is displayed indicating a fault with a specific memory module, go to step 12.
4. Enter the System Setup and check the system memory setting. Make any changes to the memory settings, if needed.  
If the memory settings match the installed memory but the problem still persists, go to step 12.
5. Turn off the system and attached peripherals, and disconnect the system from the electrical outlet.
6. Remove the system cover.
7. Check the memory channels and ensure that they are populated correctly.  
 **NOTE:** See the system event log or system messages for the location of the failed memory module. Reinstall the memory device.
8. Reseat the memory modules in their sockets.
9. Install the system.
10. Enter the System Setup and check the system memory setting.  
If the problem is not resolved, proceed with the next step.
11. Remove the system cover.
12. If a diagnostic test or error message indicates a specific memory module as faulty, swap or replace the module with a known good memory module.
13. To troubleshoot an unspecified faulty memory module, replace the memory module in the first DIMM socket with a module of the same type and capacity.  
If an error message is displayed on the screen, this may indicate a problem with the installed DIMM type(s), incorrect DIMM installation, or defective DIMM(s). Follow the on-screen instructions to resolve the problem. For more information, see [General memory module installation guidelines](#).
14. Install the system cover.
15. As the system boots, observe any error message that is displayed and the diagnostic indicators on the front of the system.
16. If the memory problem persists, repeat step 12 through step 15 for each memory module installed.

### Next steps

If the problem persists after all memory modules have been checked, see [Getting Help](#).

## Troubleshooting an internal USB key

### Prerequisites



**CAUTION:** Many repairs may only be done by a certified service technician. You should only perform troubleshooting and simple repairs as authorized in your product documentation, or as directed by the online or telephone service and support team. Damage due to servicing that is not authorized by Dell is not covered by your warranty. Read and follow the safety instructions that came with the product.

### Steps

1. Enter the System Setup and ensure that the **USB key port** is enabled on the **Integrated Devices** screen.
2. Turn off the system and attached peripherals, and disconnect the system from the electrical outlet.
3. Remove the system cover.
4. Locate the USB key and reseal it.
5. Install the system cover.
6. Turn on the system and attached peripherals and check if the USB key is functioning.
7. If the problem is not resolved, repeat step 2 and step 3.
8. Insert a different USB key that you know works properly.
9. Install the system cover.

### Next steps

If the problem is not resolved, see [Getting Help](#).

## Troubleshooting an SD card

### Prerequisites



**CAUTION:** Many repairs may only be done by a certified service technician. You should only perform troubleshooting and simple repairs as authorized in your product documentation, or as directed by the online or telephone service and support team. Damage due to servicing that is not authorized by Dell is not covered by your warranty. Read and follow the safety instructions that came with the product.



**NOTE:** Certain SD cards have a physical write-protect switch on the card. If the write-protect switch is turned on, the SD card is not writeable.

### Steps

1. Enter the System Setup and ensure that the **Internal SD Card Port** is enabled.
2. Turn off the system, including any attached peripherals, and disconnect the system from the electrical outlet.
3. Remove the system cover.
  -  **NOTE:** When an SD card failure occurs, the internal dual SD module controller notifies the system. On the next reboot, the system displays a message indicating the failure. If redundancy is enabled at the time of SD card failure, a critical alert will be logged and chassis health will degrade.
4. Replace the failed SD card with a new SD card.



5. Install the system cover.
6. Reconnect the system to its electrical outlet and turn the system on, including any attached peripherals.
7. Enter the System Setup and ensure that the **Internal SD Card Port** and **Internal SD Card Redundancy** mode is set to the required mode.  
Verify that correct SD slot is set as **Primary SD Card**.
8. Check if the SD card is functioning properly.
9. If the **Internal SD Card Redundancy** option is set to **Enabled** at the time of the SD card failure, the system will prompt you to perform a rebuild.

 **NOTE:** The rebuild will always be sourced from the primary SD card to the secondary SD card. Perform the rebuild of the SD card as necessary.

## Troubleshooting an optical drive

### Prerequisites

 **CAUTION:** Many repairs may only be done by a certified service technician. You should only perform troubleshooting and simple repairs as authorized in your product documentation, or as directed by the online or telephone service and support team. Damage due to servicing that is not authorized by Dell is not covered by your warranty. Read and follow the safety instructions that came with the product.

### Steps

1. Try using a different CD or DVD.
2. Enter the System Setup and ensure that the integrated SATA controller and the drive's SATA port are enabled.
3. Run the appropriate diagnostic test.
4. Turn off the system and attached peripherals, and disconnect the system from the electrical outlet.
5. If installed, remove the front bezel.
6. Remove the system cover.
7. Ensure that the interface cable is securely connected to the optical drive and to the controller.
8. Ensure that a power cable is properly connected to the drive.
9. Install the system cover.

### Next steps

If the problem is not resolved, see [Getting Help](#).

## Troubleshooting a tape backup unit

### Prerequisites

 **CAUTION:** Many repairs may only be done by a certified service technician. You should only perform troubleshooting and simple repairs as authorized in your product documentation, or as directed by the online or telephone service and support team. Damage due to servicing that is not authorized by Dell is not covered by your warranty. Read and follow the safety instructions that came with the product.

### Steps

1. Use a different tape cartridge.
2. Ensure that the device drivers for the tape backup unit are installed and are configured correctly. See your tape drive documentation for more information about device drivers.
3. Reinstall the tape-backup software as instructed in the tape-backup software documentation.
4. Ensure that the interface cable of the tape drive is connected to the external port on the controller card.
5. Perform the following steps to ensure that the controller card is properly installed:
  - a. Turn off the system and attached peripherals, and disconnect the system from the electrical outlet.
  - b. Remove the system cover.
  - c. Reseat the controller card in the expansion card slot.
  - d. Install the system cover.
  - e. Turn on the system and attached peripherals.
6. Run the appropriate diagnostic test. For more information, see [Using System Diagnostics](#).

### Next steps

If you cannot resolve the problem, see [Getting Help](#).

## Troubleshooting a hard drive

### Prerequisites



**CAUTION:** Many repairs may only be done by a certified service technician. You should only perform troubleshooting and simple repairs as authorized in your product documentation, or as directed by the online or telephone service and support team. Damage due to servicing that is not authorized by Dell is not covered by your warranty. Read and follow the safety instructions that came with the product.



**CAUTION:** This troubleshooting procedure can erase data stored on the hard drive. Before you proceed, back up all files on the hard drive.

### Steps

1. Run the appropriate diagnostic test. For more information, see [Using System Diagnostics](#).  
Depending on the results of the diagnostics test, proceed as needed through the following steps.
2. If your system has a RAID controller and your hard drives are configured in a RAID array, perform the following steps:
  - a. Reboot the system and press <F10> during system startup to run the Lifecycle Controller, and then run the Hardware Configuration wizard to check the RAID configuration.  
See the Lifecycle Controller documentation or online help for information on RAID configuration.
  - b. Ensure that the hard drive(s) are configured correctly for the RAID array.
  - c. Take the hard drive offline and reseat the drive.
  - d. Exit the configuration utility and allow the system to boot to the operating system.
3. Ensure that the required device drivers for your controller card are installed and are configured correctly. See the operating system documentation for more information.
4. Reboot the system and enter the System Setup.
5. Verify that the controller is enabled and the drives are displayed in the System Setup.

### Next steps

If the problem persists, try troubleshooting the expansion cards or see [Getting Help](#).

## Troubleshooting a storage controller

 **CAUTION:** Many repairs may only be done by a certified service technician. You should only perform troubleshooting and simple repairs as authorized in your product documentation, or as directed by the online or telephone service and support team. Damage due to servicing that is not authorized by Dell is not covered by your warranty. Read and follow the safety instructions that came with the product.

 **NOTE:** When troubleshooting a SAS or PERC controller, see the documentation for your operating system and the controller.

1. Run the appropriate diagnostic test. For more information, see [Using System Diagnostics](#).
2. Turn off the system and attached peripherals, and disconnect the system from the electrical outlet.
3. Remove the system cover.
4. Verify that the installed expansion cards are compliant with the expansion card installation guidelines.
5. Ensure that each expansion card is firmly seated in its connector.
6. Install the system cover.
7. Reconnect the system to the electrical outlet, and turn on the system and attached peripherals.
8. If the problem is not resolved, turn off the system and attached peripherals, and disconnect the system from the electrical outlet.
9. Remove the system cover.
10. Remove all expansion cards installed in the system.
11. Install the system cover.
12. Reconnect the system to the electrical outlet, and turn on the system and attached peripherals.
13. Run the appropriate diagnostic test. For more information, see [Using System Diagnostics](#). If the tests fail, see [Getting Help](#).
14. For each expansion card you removed in step 10, perform the following steps:
  - a. Turn off the system and attached peripherals, and disconnect the system from the electrical outlet.
  - b. Remove the system cover.
  - c. Reinstall one of the expansion cards.
  - d. Install the system cover.
  - e. Run the appropriate diagnostic test. For more information, see [Using System Diagnostics](#).

If the tests fail, see [Getting Help](#).

## Troubleshooting expansion cards

### Prerequisites

 **CAUTION:** Many repairs may only be done by a certified service technician. You should only perform troubleshooting and simple repairs as authorized in your product documentation, or as directed by the online or telephone service and support team. Damage due to servicing that is not authorized by Dell is not covered by your warranty. Read and follow the safety instructions that came with the product.

 **NOTE:** When troubleshooting an expansion card, see the documentation for your operating system and the expansion card.

### Steps

1. Run the appropriate diagnostic test. For more information, see [Using System Diagnostics](#).
2. Turn off the system and attached peripherals, and disconnect the system from the electrical outlet.
3. Remove the system cover.
4. Ensure that each expansion card is firmly seated in its connector.
5. Install the system cover.
6. If the problem is not resolved, turn off the system and attached peripherals, and disconnect the system from the electrical outlet.
7. Remove the system cover.
8. Remove all expansion cards installed in the system.
9. Install the system cover.  
If the tests fail, see [Getting Help](#).
10. For each expansion card you removed in step 8, perform the following steps:
  - a. Turn off the system and attached peripherals, and disconnect the system from the electrical outlet.
  - b. Remove the system cover.
  - c. Reinstall one of the expansion cards.
  - d. Install the system cover.
  - e. Run the appropriate diagnostic test. For more information, see [Using System Diagnostics](#).

### Next steps

If the problem persists, see [Getting Help](#).

## Troubleshooting processors

### Prerequisites



**CAUTION:** Many repairs may only be done by a certified service technician. You should only perform troubleshooting and simple repairs as authorized in your product documentation, or as directed by the online or telephone service and support team. Damage due to servicing that is not authorized by Dell is not covered by your warranty. Read and follow the safety instructions that came with the product.

### Steps

1. Run the appropriate diagnostics test. See [Using System Diagnostics](#) for available diagnostic tests.
2. Turn off the system and attached peripherals, and disconnect the system from the electrical outlet.
3. Remove the system cover.
4. Ensure that the processor and heat sink are properly installed.
5. Install the system cover.
6. Run the appropriate diagnostic test. For more information, see [Using System Diagnostics](#).

### Next steps

If the problem persists, see [Getting Help](#).

## System messages

For a list of event and error messages generated by the system firmware and agents that monitor system components, see the Dell Event and Error Messages Reference Guide at [dell.com/esmanuals](http://dell.com/esmanuals).

### Warning messages

A warning message alerts you to a possible problem and prompts you to respond before the system continues a task. For example, before you format a hard drive, a message warns you that you may lose all data on the hard drive. Warning messages usually interrupt the task and require you to respond by typing y (yes) or n (no).

 **NOTE:** Warning messages are generated by either the application or the operating system. For more information, see the documentation that accompanied the operating system or application.

### Diagnostic messages

The system diagnostic utilities may issue messages if you run diagnostic tests on your system. See the [Using system diagnostics](#) for more information about system diagnostics.

### Alert messages

The systems management software generates alert messages for your system. Alert messages include information, status, warning, and failure messages for drive, temperature, fan, and power conditions. For more information, see the systems management software documentation.

# Using system diagnostics

If you experience a problem with your system, run the system diagnostics before contacting Dell for technical assistance. The purpose of running system diagnostics is to test your system hardware without requiring additional equipment or risking data loss. If you are unable to fix the problem yourself, service and support personnel can use the diagnostics results to help you solve the problem.

## Dell Embedded System Diagnostics

 **NOTE:** The Dell Embedded System Diagnostics is also known as Enhanced Pre-boot System Assessment (ePSA) diagnostics.

The embedded system diagnostics provides a set of options for particular device groups or devices allowing you to:

- Run tests automatically or in an interactive mode
- Repeat tests
- Display or save test results
- Run thorough tests to introduce additional test options to provide extra information about the failed device(s)
- View status messages that inform you if tests are completed successfully
- View error messages that inform you of problems encountered during testing

### When to use the Embedded System Diagnostics

If a major component or device in the system does not operate properly, running the embedded system diagnostics may indicate component failure.

### Running the Embedded System Diagnostics from Boot Manager

1. As the system boots, press <F11>.
2. Use the up and down arrow keys to select **System Utilities** → **Launch Diagnostics**.  
The **ePSA Pre-boot System Assessment** window is displayed, listing all devices detected in the system. The diagnostics starts executing the tests on all the detected devices.

### Running the Embedded System Diagnostics from the Dell Lifecycle Controller

1. As the system boots, press <F11>.
2. Select **Hardware Diagnostics** → **Run Hardware Diagnostics**.  
The **ePSA Pre-boot System Assessment** window is displayed, listing all devices detected in the system. The diagnostics starts executing the tests on all the detected devices.

## System diagnostic controls

Menu	Description
Configuration	Displays the configuration and status information of all detected devices.
Results	Displays the results of all tests that are executed.
System health	Provides the current overview of the system performance.
Event log	Displays a time-stamped log of the results of all tests run on the system. This is displayed if at least one event description is recorded.

For information about embedded system diagnostics, see the *ePSA Diagnostics Guide (Notebooks, Desktops and Servers)* at [dell.com/support/manuals](https://dell.com/support/manuals).

# Jumpers and connectors

## System board connectors

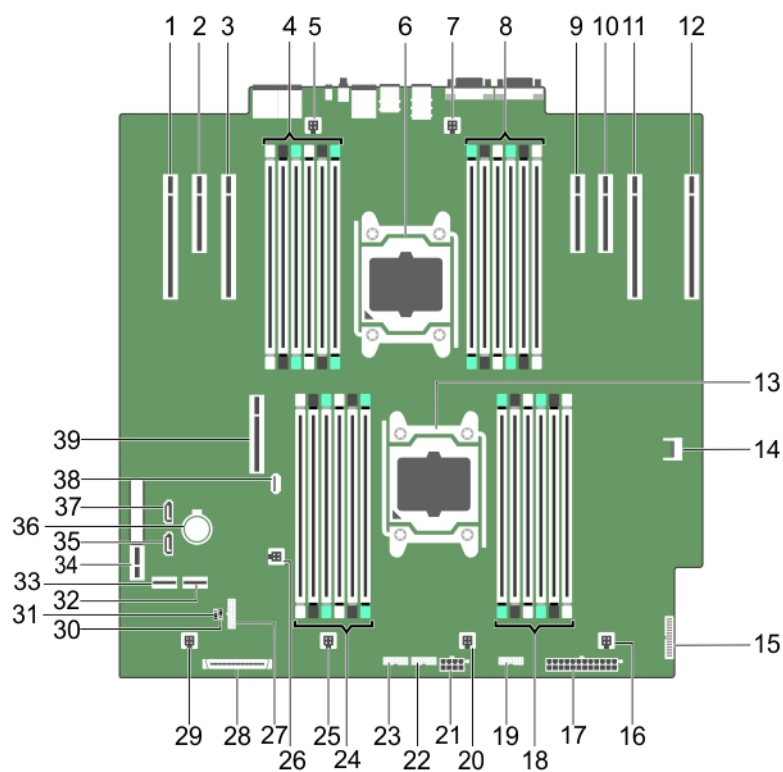

Figure 72. System board jumpers and connectors

Item	Connector	Description
1	SLOT1 PCIE_G3_X16 (CPU1)	PCIe card connector 1
2	SLOT2 PCIE_G2_X4 (PCH)	PCIe card connector 2
3	SLOT3 PCIE_G3_X16 (CPU1)	PCIe card connector 3
4	B1, B5, B9, B2, B6, B10	Memory module sockets
5	FAN1	Cooling shroud fan connector
6	CPU2	Processor 2
7	FAN2	Fan connector







Item	Connector	Description
8	B12, B8, B4, B11, B7, B3	Memory module sockets
9	SLOT4 PCIE_G3_X8 (CPU2)	PCIe card connector 4
10	SLOT5 PCIE_G2_X4 (CPU2)	PCIe card connector 5
11	SLOT6 PCIE_G3_X16 (CPU2)	PCIe card connector 6
12	SLOT7 PCIE_G3_X16 (CPU2)	PCIe card connector 7
13	CPU1	Processor 1
14	TPM_Module	Trusted Platform Module (TPM) connector
15	PIB_CONN	PIB signal connector
16	FAN6	Fan connector
17	PWR_CONN_2	PIB signal connector
18	A10, A6, A2, A9, A5, A1	Memory module sockets
19	BP_SIG2	Backplane signal connector 2
20	FAN5	Cooling shroud fan connector
21	PWR_CONN_1	Power connector
22	BP_SIG1	Backplane signal connector 1
23	BP_SIG0	Dell PowerEdge Express Flash (PCIe SSD) signal connector
24	A3, A7, A11, A4, A8, A12	Memory module sockets
25	FAN4	Cooling shroud fan connector
26	INTRUSION	Chassis intrusion switch connector
27	FP_USB	Control panel USB connector
28	CTRL_PNL	Control panel interface connector
29	FAN3	Cooling shroud fan connector
30	NVRAM_CLR	See <a href="#">System board jumper settings</a>
31	PWRD_EN	See <a href="#">System board jumper settings</a>
32	SW RAID_B	SW RAID connector 2
33	SW RAID_A	SW RAID connector 1
34	IDSDM	Internal dual SD module connector
35	SATA_TBU	Tape drive SATA connector
36	BATTERY	System battery connector
37	SATA_CDRUM	Optical drive SATA connector
38	INT_USB_3.0	Internal USB 3.0 connector
39	SLOT8 PCIE_G3_X8 (CPU1)	PCIe card connector 8

# System board jumper settings

For information on resetting the password jumper to disable a password, see [Disabling a forgotten password](#).

Table 5. System board jumper settings

Jumper	Setting	Description
PWRD_EN	 (default)	The password reset feature is enabled (pins 2–4). BIOS local access is unlocked at the next AC power cycle.
		The password reset feature is disabled (pins 4–6).
NVRAM_CLR	 (default)	The configuration settings are retained at the next system boot (pins 3–5).
		The configuration settings are cleared at system boot (pins 1–3).

## Disabling a forgotten password

The system's software security features include a system password and a setup password. The password jumper enables these password features or disables them and clears any password(s) currently in use.

### Prerequisites

**CAUTION:** Many repairs may only be done by a certified service technician. You should only perform troubleshooting and simple repairs as authorized in your product documentation, or as directed by the online or telephone service and support team. Damage due to servicing that is not authorized by Dell is not covered by your warranty. Read and follow the safety instructions that came with the product.

### Steps

1. Turn off the system, including any attached peripherals, and disconnect the system from the electrical outlet.
2. Remove the system cover.
3. Move the jumper on the system-board jumper from pins 2 and 4 to pins 4 and 6.
4. Install the system cover.



The existing passwords are not disabled (erased) until the system boots with the Jumper on pins 4 and 6. However, before you assign a new system and/or setup password, you must move the jumper back to pins 2 and 4.

**NOTE:** If you assign a new system and/or setup password with the jumper on pins 4 and 6, the system disables the new password(s) the next time it boots.
5. Reconnect the system to its electrical outlet and turn the system on, including any attached peripherals.
6. Turn off the system, including any attached peripherals, and disconnect the system from the electrical outlet.
7. Remove the system cover.

- 8.** Move the jumper on the system-board jumper from pins 4 and 6 to pins 2 and 4.
- 9.** Install the system cover.
- 10.** Reconnect the system to its electrical outlet and turn the system on, including any attached peripherals.
- 11.** Assign a new system and/or setup password.

## Technical specifications

Technical specifications help you in replacing or upgrading a component in the system. Environmental specifications help you deploy the system for optimum efficiency.

<b>Physical</b>	
Height	443.5 mm (17.5 inch) with feet 434.5 mm (17.1 inch) without feet
Width	304.5 mm (11.98 inch) with feet opened 217.9 mm (8.57 inch) with feet closed
Depth	692.8 mm (27.27 inch) without bezel 708.7 mm (27.9 inch) with bezel
Weight (maximum configuration)	51.0 kg (112.43 lb) for 3.5 inch hard-drive chassis 41.8 kg (92.15 lb) for 2.5 inch hard-drive chassis
<b>Processor</b>	
Processor type	One or two Intel Xeon processor E5-2600 v3 product family
<b>Power</b>	
AC power supply (per power supply)	
Wattage	495 W, 750 W, 1100 W, or 1600 W
Heat dissipation	1908 BTU/hr maximum (495 W power supply)
 <b>NOTE:</b> Heat dissipation is calculated using the power supply wattage rating.	2891 BTU/hr maximum (750 W power supply)
	2843 BTU/hr maximum (750 W Titanium power supply)
	4100 BTU/hr maximum (1100 W power supply)
	5463 BTU/hr maximum (1600 W DC power supply)
Voltage	100–240 V AC, autoranging, 50/60 Hz
 <b>NOTE:</b> This system is also designed to be connected to IT power systems with a phase to phase voltage not exceeding 230 V.	or 200–240 V AC, autoranging, 50/60 Hz, for 750 W Titanium power supply

---

**Power**

---

## DC power supply (per power supply)

Wattage	1100 W
Heat dissipation	4416 BTU/hour maximum
 <b>NOTE:</b> Heat dissipation is calculated using the power supply wattage rating.	
Voltage	-(48–60) V DC



 **NOTE:** This system is also designed to be connected to IT power systems with a phase to phase voltage not exceeding 230 V.

System battery CR 2032 3.0-V lithium coin cell

---

**Expansion Bus**

---

Bus type	PCI Express Generation 3 and 2
Expansion slots	(Slot 1) One full-height, full-length x16 link (Slot 2) One full-height, full-length x4 link  <b>NOTE:</b> Slot 2 is PCI Express Generation 2 only. (Slot 3) One full-height, full-length, x16 link  <b>NOTE:</b> Both the processors must be installed to use slots 4 through 7. (Slot 4) One full-height, half-length x8 link (Slot 5) One full-height, full-length x4 link  <b>NOTE:</b> Slot 5 is PCI Express Generation 2 only. (Slot 6) One full-height, full-length x16 link (Slot 7) One full-height, full-length x16 link (Slot 8) One full-height, half-length x8 link

---

**Memory**

---

Architecture	1333 MT/s, 1600 MT/s, 1866 MT/s, or 2133 MT/s DDR4 Registered or Load-Reduced Error Correcting Code (ECC) DIMMs  Support for advanced ECC or memory optimized operation
Memory module sockets	Twenty-four 288-pin

---

**Memory**

---

## Memory module capacities

LRDIMMs	32 GB quad-ranked
RDIMMs	4 GB single-ranked, 8 GB or 16 GB dual-ranked
Minimum RAM	4 GB with a single processor 8 GB with a dual processor
Maximum RAM	Up to 384 GB with single processor Up to 786 GB with dual processor



---

**Drives**

---

## Hard drives

Eight-hard-drive systems	Up to eight 3.5 inch, internal, hot-swappable SAS, SATA, SSD, or Nearline SAS hard drives or Up to eight 2.5 inch, internal, hot-swappable SAS, SATA, SSD, or Nearline SAS hard drives in a 3.5 inch hard-drive carrier  Hard-drive slots 0 through 3 and 4 through 7
Eight plus four-hard drive systems	Up to eight 3.5 inch, internal, hot-swappable SAS, SATA, SSD, or Nearline SAS hard drives plus four Dell PowerEdge Express Flash devices (PCIe SSDs) Hard-drive slots 0 through 7 and 0 through 3
Eighteen hard-drive systems	Up to eighteen 3.5 inch, internal, hot-swappable SAS, SATA, SSD, or Nearline SAS hard drives Hard-drive slots 0 through 5, 6 through 11, and 12 through 17
Sixteen hard-drive systems	Up to sixteen 2.5 inch, internal, hot-swappable SAS, SATA, SSD, or Nearline SAS hard drives hard-drive slots 0 through 7 and 8 through 15
Sixteen plus four hard-drive systems	Up to sixteen 2.5 inch, internal, hot-swappable SAS, SATA, or SSD hard drives plus four PCIe SSDs Hard-drive slots 0 through 3, 0 through 7, and 8 through 15
Thirty two-hard-drive systems with a single PERC card	Up to thirty-two 2.5 inch, internal, hot-swappable SAS, SATA, SSD, or Nearline SAS hard drives Hard-drive slots 0 through 7, 8 through 15, 16 through 23, and 24 through 31
Thirty two-hard-drive systems with double PERC card	Up to thirty-two 2.5 inch, internal, hot-swappable SAS, SATA, SATA SSD, or Nearline SAS hard drives

<b>Drives</b>	
	Hard-drive slots 0 through 7, 8 through 15, 0 through 7, and 8 through 15
Optical drive	One optional SATA DVD-ROM drive or DVD+/-RW drive or One optional slim SATA DVD-ROM drive or DVD+/-RW drive
	 <b>NOTE:</b> DVD devices are data only.
<b>Connectors</b>	
<b>Back</b>	
NIC	Two 10/100/1000 Mbps
Serial	DB-9 Serial Port connector
USB	Six Hi-Speed USB Host (Four USB 2.0 and two USB 3.0)
Video	15-pin VGA
<b>Front</b>	
USB	Two Hi-Speed USB Host (One USB 2.0 and one USB 3.0)
Video	15-pin VGA
	 <b>NOTE:</b> The front VGA port is available only with the rack configuration.
External vFlash memory card	One vFlash memory card slot
<b>Internal</b>	
USB	One 4-pin, USB 3.0-compliant
Internal Dual SD Module	Two optional flash memory card slots with the internal SD module
	 <b>NOTE:</b> One card slot is dedicated for redundancy.
<b>Video</b>	
Video type	Integrated Matrox G200 with iDRAC8
Video memory	16 MB shared with iDRAC8 application memory

---

## Environmental specifications

---

 **NOTE:** For additional information about environmental measurements for specific system configurations, see [dell.com/environmental\\_datasheets](https://dell.com/environmental_datasheets).

### Temperature

Storage	–40°C to 65°C (–40°F to 149°F)
Continuous operation (for altitude less than 950 m or 3117 ft)	10°C to 35°C (50°F to 95°F) with no direct sunlight on the equipment.
Fresh air	For information on fresh air, see Expanded Operating Temperature section.
Maximum temperature gradient (operating and storage)	20°C/h (36°F/h)

### Relative humidity

Storage	5% to 95% RH with 33°C (91°F) maximum dew point. Atmosphere must be non-condensing at all times.
Operating	10% to 80% Relative Humidity with 29°C (84.2°F) maximum dew point.

### Maximum vibration

Operating	0.26 G <sub>rms</sub> at 5 Hz to 350 Hz (all operation orientations).
Storage	1.88 G <sub>rms</sub> at 10 Hz to 500 Hz for 15 min (all six sides tested).

### Maximum shock

Operating	Six consecutively executed shock pulses in the positive and negative x, y, and z axes of 40 G for up to 2.3 ms.
Storage	Six consecutively executed shock pulses in the positive and negative x, y, and z axes (one pulse on each side of the system) of 71 G for up to 2 ms.

### Maximum altitude

Operating	3048 m (10,000 ft).
Storage	12,000 m (39,370 ft).

### Operating temperature de-rating

Up to 35 °C (95 °F)	Maximum temperature is reduced by 1°C/300 m (1°F/547 ft) above 950 m (3,117 ft).
35 °C to 40 °C (95 °F to 104 °F)	Maximum temperature is reduced by 1°C/175 m (1°F/319 ft) above 950 m (3,117 ft).



---

**Environmental specifications**

---

40 °C to 45 °C (104 °F to 113 °F)

Maximum temperature is reduced by 1°C/125 m (1°F/228 ft) above 950 m (3,117 ft).

**Particulate contamination**

 **NOTE:** This section defines the limits to help avoid IT equipment damage and/or failure from particulates and gaseous contamination. If it is determined that levels of particulates or gaseous pollution are beyond the limits specified below and are the reason for the damage and/or failures to your equipment, it may be necessary for you to re-mediate the environmental conditions that are causing the damage and/or failures. Re-mediation of environmental conditions will be the responsibility of the customer.

Air filtration

Data center air filtration as defined by ISO Class 8 per ISO 14644-1 with a 95% upper confidence limit.

 **NOTE:** Applies to data center environments only. Air filtration requirements do not apply to IT equipment designed to be used outside a data center, in environments such as an office or factory floor.

 **NOTE:** Air entering the data center must have MERV11 or MERV13 filtration.

Conductive dust

Air must be free of conductive dust, zinc whiskers, or other conductive particles.

 **NOTE:** Applies to data center and non-data center environments.

Corrosive dust

- Air must be free of corrosive dust.
- Residual dust present in the air must have a deliquescent point less than 60% relative humidity.

 **NOTE:** Applies to data center and non-data center environments.

**Gaseous contamination**

 **NOTE:** Maximum corrosive contaminant levels measured at  $\leq 50\%$  relative humidity.

Copper coupon corrosion rate

$<300 \text{ \AA}/\text{month}$  per Class G1 as defined by ANSI/ISA71.04-1985.

Silver coupon corrosion rate

$<200 \text{ \AA}/\text{month}$  as defined by AHSRAE TC9.9.

---

**Expanded operating temperature**

---

 **NOTE:** When operating in the expanded temperature range, system performance may be impacted.

 **NOTE:** When operating in the expanded temperature range, ambient temperature warnings may be reported on the LCD and in the System Event Log.

Continuous operation

5°C to 40°C at 5% to 85% RH with 29°C dew point.

 **NOTE:** Outside the standard operating temperature (10°C to 35°C), the system can operate continuously down to 5°C or as high as 40°C.

---

## Expanded operating temperature

---

$\leq 1\%$ of annual operating hours	<p>For temperatures between 35°C and 40°C, de-rate maximum allowable temperature by 1°C per 175 m above 950 m (1°F per 319 ft).</p> <p>–5°C to 45°C at 5% to 90% RH with 29°C dew point.</p> <p> <b>NOTE:</b> Outside the standard operating temperature (10°C to 35°C), the system can operate down to –5°C or up to 45°C for a maximum of 1% of its annual operating hours.</p> <p>For temperatures between 40°C and 45°C, de-rate maximum allowable temperature by 1°C per 125 m above 950 m (1°F per 228 ft).</p>
--------------------------------------	--

## Expanded Operating Temperature Restrictions

- You must have six fans configured on your system.
- Do not perform a cold startup below 5°C.
- The operating temperature specified is for a maximum altitude of 3048 m (10,000 ft).
- Express Flash is not supported.
- GPU is not supported.
- 160 W workstation CPU is not supported.
- Internal TBU (Tape Backup Unit) is not supported.
- Two power supplies in redundant mode are required, but do not support PSU failure function.
- Non Dell qualified peripheral cards and/or peripheral cards greater than 25 W are not supported.
- PCIeSSD is not supported.
- Eighteen 3.5 inch hard-drive configuration is not supported.
- Fusion IO is not supported.

# Getting help

## Contacting Dell

### About this task

 **NOTE:** Dell provides several online and telephone-based support and service options. If you do not have an active Internet connection, you can find contact information on your purchase invoice, packing slip, bill, or Dell product catalog. Availability varies by country and product, and some services may not be available in your area.

To contact Dell for sales, technical support, or customer-service issues:

### Steps

1. Go to **dell.com/support**.
2. Select your country from the drop-down menu on the top left corner of the page.
3. For customized support:
  - a. Enter your system service tag in the **Enter your Service Tag** field.
  - b. Click **Submit**.

The support page that lists the various support categories is displayed.

4. For general support:
  - a. Select your product category.
  - b. Select your product segment.
  - c. Select your product.

The support page that lists the various support categories is displayed.

## Locating your system service tag

Your system is identified by a unique Express Service Code and Service Tag number. The Express Service Code and Service Tag are found on the front of the system by pulling out the information tag. Alternatively, the information may be on a sticker on the chassis of the system. This information is used by Dell to route support calls to the appropriate personnel.

## Quick Resource Locator (QRL)

Use the Quick Resource Locator (QRL) to get immediate access to system information and how-to videos. This can be done by visiting **dell.com/QRL** or by scanning a model specific QR code located on your Dell PowerEdge system using your smartphones or tablets. You can also access your system information and how-to videos by scanning the following QR code.

